

ARGUS25 Manual

**© by intec GmbH, D-58507 Lüdenscheid, Germany,
2001**

Alle Rechte, auch der Übersetzung, vorbehalten. Kein Teil des Werkes darf in irgendeiner Form (Druck, Fotokopie, Mikrofilm oder einem anderen Verfahren) ohne schriftliche Genehmigung reproduziert, vervielfältigt oder verbreitet werden.

All rights are reserved. No one is permitted to reproduce or duplicate, in any form, the whole or part of this document without intec's permission.

Version: 3.0

1	Introduction	7
2	Safety Notices	11
3	Technical Data	12
4	Operation	13
5	Menu Hierarchy	17
6	Menus	27
6.1	Automatic Access Test	27
6.2	Status display	34
6.3	Keys	35
6.4	Menu: Access	37
	6.4.1 Selection of the physical access	38
	6.4.2 Line test	39
6.5	Menu: Access mode	43
	6.5.1 Operation on a BRI or a PRI access	43
	6.5.1.1 TE-Simulation mode	43
	6.5.1.2 NT-Simulation mode P-P or P-MP	43
	6.5.1.3 Permanent switch	44
	6.5.1.4 BRI/PRI Monitor	47
	6.5.1.5 BRI/PRI Recorder	51
	6.5.2 Operation on a U interface access	60
	6.5.2.1 TE-Simulation mode	60
	6.5.2.2 Permanent circuit	60
	6.5.3 Operation on an analog access	60
	6.5.3.1 a/b terminal	60
	6.5.3.2 a/b monitor	60
6.6	Menu: Single Tests	62
	6.6.1 Connection	63
	6.6.1.1 Setting up an ISDN connection	63
	6.6.2 Clearing down an ISDN connection	71
	6.6.2.1 Operation on an analog (a/b) access	73
	6.6.3 Time measuring	76
	6.6.3.1 Connection setup time	77
	6.6.3.2 B-channel delay	78
	6.6.3.3 Interchannel delay	79
	6.6.4 Suppl.serv.tests DSS1	81
	6.6.4.1 Suppl. Services Test with 1TR6	81
	6.6.4.2 Suppl.service interrogation in DSS1	83
	6.6.4.3 Suppl. Services Tests – Error messages	91
	6.6.5 Service check	92
	6.6.6 Bit error test	95
	6.6.6.1 BERT start	97
	6.6.6.2 Bert wait	102
	6.6.6.3 B-channel loop	103

6.6.7 X.31 Test (only on a BRI access)	105
6.6.8 CF interrogation (only on a BRI access) .	107
6.7 Menu: Test Manager	110
6.7.1 Starting Several Tests	111
6.7.2 Switching Between Tests	116
6.7.3 Cancel all	116
6.8 Menu: Automatic Test	117
6.8.1 Starting the Automatic Test	119
6.8.2 Display result	122
6.8.3 Test results – sending to a PC	123
6.8.4 Printing the test results (optional)	124
6.9 Menu: Configuration	125
6.9.1 Trace mode	125
6.9.2 Configuration: ISDN	126
6.9.2.1 Layer 1 permanent	127
6.9.2.2 Select the D-channel protocol	128
6.9.2.3 Alerting mode	129
6.9.2.4 Clock mode	130
6.9.2.5 BRI termination	131
6.9.2.6 PRI termination	132
6.9.2.7 U coding	133
6.9.2.8 PRI Sensitivity (Haul Mode)	134
6.9.2.9 Setting the Sa5 Bits	135
6.9.2.10 Setting the Sa6 Bits	136
6.9.2.11 Call Parameter	137
6.9.2.12 Call Acceptance	139
6.9.3 Configuration: BERT	140
6.9.3.1 BERT - duration	141
6.9.3.2 HRX value	142
6.9.3.3 BERT - Setting the Error Level	143
6.9.3.4 Selecting the BERT bit pattern	144
6.9.4 Configuration: Analog	146
6.9.4.1 Analog dial mode	146
6.9.4.2 Analog CLIP	147
6.9.4.3 Analog Message	148
6.9.4.4 AOC pulse	149
6.9.4.5 DTMF parameter	150
6.9.4.6 FLASH time	155
6.9.5 Configuration: ARGUS	156
6.9.5.1 Selecting the menu language	156
6.9.5.2 Setting the display contrast	157
6.9.5.3 Date / Time	158
6.9.5.4 Handset	159
6.9.5.5 Printer	160
6.9.5.6 Alarm bell	162
6.9.5.7 Baud Rate	163

6.9.5.8 PC Access	164
6.9.6 Saving Call Numbers	165
6.9.7 Reset	166
6.10 Menu: Level measuring	168
6.10.1 Level measuring on a BRI access	169
6.10.2 Level measurement on a U interface	171
6.10.3 Level measuring on an analog access ..	174
6.11 Menu: L1 status	175
6.11.1 The L1 status of a BRI access	175
6.11.2 The L1 status of a PRI access	176
6.12 Testing Features with the Keypad	179
7 Connection for a PRI network	181
7.1 Connector Pin Assignments	181
7.2 Connection to DTAG NTPM	181
7.3 The ARGUS 25 as Terminal	182
8 Appendix	183
A) Acronyms	183
B) CAUSE-Messages – DSS1 Protocol	186
C) CAUSE-Messages – 1TR6 Protocol	188
D) ARGUS Error Messages	190
E) Package contents	192

1 Introduction

ARGUS tests the operation of
an ISDN Basic Rate Interface (BRI)
a Primary Rate Interface (PRI)
U-interface and
an analog access.

The ARGUS Flash-ROM technology permits the user to download future protocol changes or new functions from a PC into the ARGUS.

If you use the ARGUS on a BRI or PRI interface in an ISDN system whose specifications deviate from the (DIN ETS 300 102) standard (e.g. some networked PBXs), you must take these manufacturer-specific modifications into account. In such cases, please contact the distributor of your ISDN PBX for assistance.

The ARGUS Functions - Overview:

- **Protocol Recognition and B-Channel Test**

After you select the operation mode, the ARGUS will automatically determine the protocol used by the access under test and will then test the availability of the B-channels.

- **Telephone connections**

Can a telephone call be placed from this access to every other number and/or can this access receive a call?

- **Service tests**

Does the tested access support connections with the most important services, such as, ISDN telephone service, Group 4 - Facsimile or data transmission at 64 kbit/s etc.?

- **Bit error tests (BERT)**

Performs a BERT in an extended call to itself via a loopbox or in end-to-end operation. The ARGUS will, if needed, handle the loopbox function itself.

- **Supplementary Services**

ARGUS automatically tests the supplementary services made available by the exchange.

- **Tests leased lines (permanent circuits) with BERT and speech**
- **NT simulation of a BRI- or a PRI access**
- **D-channel monitoring on the Basic- and Primary-Rate Interfaces**

All of the D-channel signals are captured and passed to the serial or infrared interface.

When passively monitoring, the ARGUS does not affect the Layer 1.

- **Analog (a/b) Functionality**

Does the analog access support call number transfer?

The ARGUS will display the charges, if the access supports this feature.

- **Monitoring an analog line (passive listening-in)**

- **Line tests**

Checks the terminating resistors for the cabling of a four-wire bus.

Detects cabling problems (e.g. broken wires, short-circuits or crossed wires).

- **The Access Acceptance Report**

When the ARGUS is linked to a PC via the serial or infrared interface, it is, as an example, possible to create and print a comprehensive test report on the PC.

- **Testing Features with the Keypad**

Manual test possibilities in the so-called keypad mode. If the network supports this feature, the user can send a command sequence and can then test the service features in a dialog.

Should you have any further questions, please contact us:

intec GmbH

Rahmedestr. 90

D-58507 Lüdenscheid

Tel.: +49 (0) 2351 / 9070-0

Fax: +49 (0) 2351 / 9070-70

2 Safety Notices

The ARGUS may only be used with the included accessories. Usage of other accessories may lead to erroneous measurements and may even cause damage to the ARGUS and the connected installation.

The ARGUS is only to be used in accordance with the instructions in this documentation. Any other usage may result in bodily injury and destruction of the ARGUS.



- To prevent electrical shocks or damage to the ARGUS, do not connect it to lines with voltages in excess of 100V!
- Never attempt a measurement with the case open!
- The ARGUS is not watertight. Protect the ARGUS from exposure to water!
- Before replacing the battery(see page 15 Changing the batteries), disconnect all the test leads and switch the ARGUS off.
Make certain that the polarity is correct when connecting the batteries!

3 Technical Data

Dimensions / Weight	Inputs / Outputs
Height 229 mm	1 RJ45 for BRI, PRI, U _k or analog
Width 72 mm	
Depth 35 mm	
Weight 350 g (without batteries and protective case)	1 jack for an external power supply
Keypad	1 RJ45 for Line test and serial transfer
21 Keys	
	IrDa Interface
LCD display	
LCD display with	
switchable	Temperature Ranges
background lighting	Ambient-temperature:
4 lines with 16 characters	0 °C to +50 °C
	Operating temperature:
Memory	-5 °C to +55 °C
EEPROM Non-volatile	
memory: 2048 Bytes	
Flash program	Power
memory: 1 Mbyte	Supply
S-RAM: 128 Kbytes	3 AA (Mignons)
	or
Data memory: 4 Mbytes (Flash)	9 V, plug-in power supply
	or
	BRI feed

4 Operation

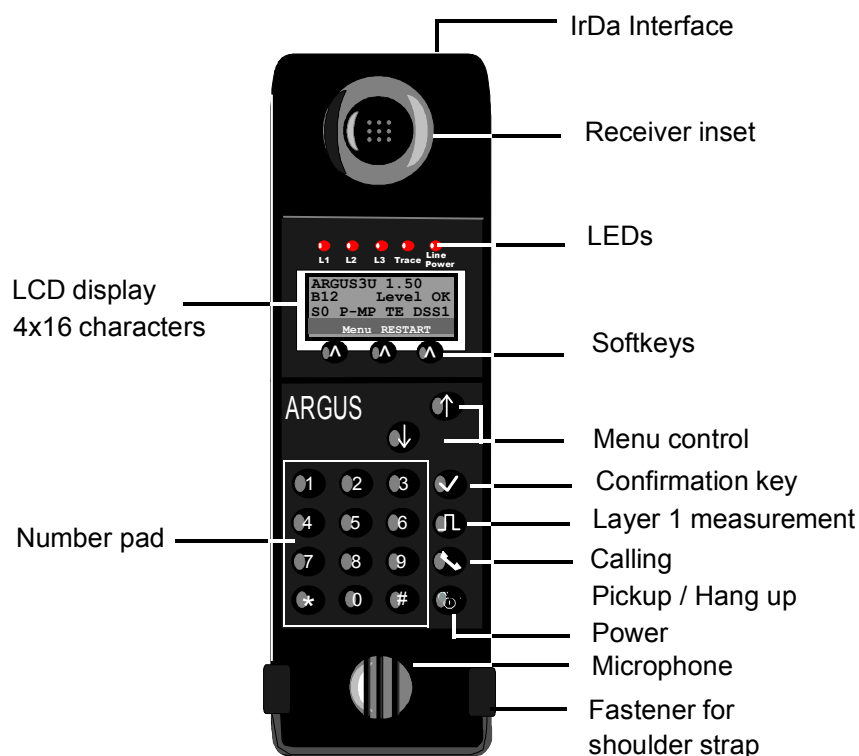
**Power-Key:**

- To switch the ARGUS ON/OFF
- To start up again after a power down
- Switches on the display backlighting (to save power, in battery mode the backlighting is switched OFF automatically after 5sec.)
- To switch the ARGUS OFF (must be pressed somewhat longer)

**Confirmation key:**

- Select menu or continue

**Menu control:**

- Open the menu list
- Scroll through lists
- Select a menu
- Select a function in an open menu

**Telephony** (pickup and hang up)

- Simplified overlap signalling: Press the telephone key twice.



Layer 1 Measurement:

Start the Layer 1 measurement (Level/Voltage)

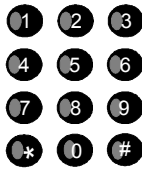

Number Pad:

- Entry of the digits 0...9 and of the special characters *, # (e.g. the call number or numerical entry in a function)
- Direct function call (see Chap. 6.3 Keys)



Softkeys:

The function of the 3 softkeys varies with the situation. The current function of each softkey is shown in the highlighted fourth line of the display.

Connectors on the End:

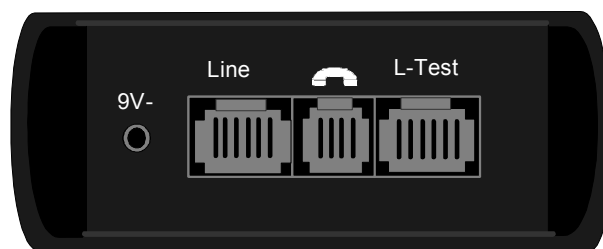

- **9 V-**
Connection for the external power supply. When the power supply is plugged into this connector, the battery will be disconnected.
- **Line**  Pin Assignment
3/4/5/6 **BRI**
7/8 **Uk and analog (a/b)**
Pin assignment for **PRI** see Chap. 7
 - Connection for BRI lines (TE simulation or monitoring)
 - Connection for a BRI terminal (NT-Simulation)
 - Connection for a PRI terminal (NT-Simulation)
 - Connection for an analog network
 - Connection for a U_k network
 - Connection for a PRI network (TE simulation or monitoring)



- Connector for a Headset
- **L-Test**
 - Connection for the test adapter for line tests
 - Serial interface to connect a PC or - via a serial/parallel adapter - a parallel printer

Infrared Interface

The wireless transfer of data to a PC is possible using the integrated infrared interface.

The infrared interface must be in the line of sight of the receiver. During data transfers, the IR beam can be interrupted for up to 30 sec without disturbing the transfer. During the interruption, the data will be buffered and will therefore not be lost.

During the recognition phase, the ARGUS must be within 20 cm of the PC's infrared receiver. Later, during the data transfer, the IR-link will work at distances of – depending on the baud rate – up to 70 cm.

Changing the batteries

The battery compartment for three AA (Mignon) batteries or accumulators is located on the back of the case. Unscrew the screws to remove the cover of the case and insert the batteries in accordance with the polarity marking.

A battery symbol begins to blink in the LCD display, when there is still approximately 15 minutes reserve. During this period, it is possible that there may be audible interference and in rare cases even malfunctions.

Power Down

In battery operation, if the ARGUS is idle for 15 minutes, it will automatically switch to the power-down mode (power-down). From this mode, the system can only be reactivated by pressing the Power-Key. In the power-down mode, a battery will last about 3.8 years. Therefore, this mode serves as an effective protection against discharging the batteries.

4 Operation

Naturally, when the loopback function is active on the ARGUS or it is in Trace mode, the ARGUS will **not** switch to power-down mode.

As an alternative, it is possible to operate the ARGUS using the included power supply. When the power supply is connected, the battery is automatically disconnected.

The ARGUS can also be powered from the BRI line. In this case, it does not need batteries, accumulators, or the plug-in power supply.

Whenever the ARGUS is powered from the plug-in power supply or the BRI line, the power-down mode is reasonably enough not active.



Regardless of the type of supply used, you should always operate the ARGUS with batteries installed. This will ensure the uninterrupted operation of the real-time clock.

5 Menu Hierarchy

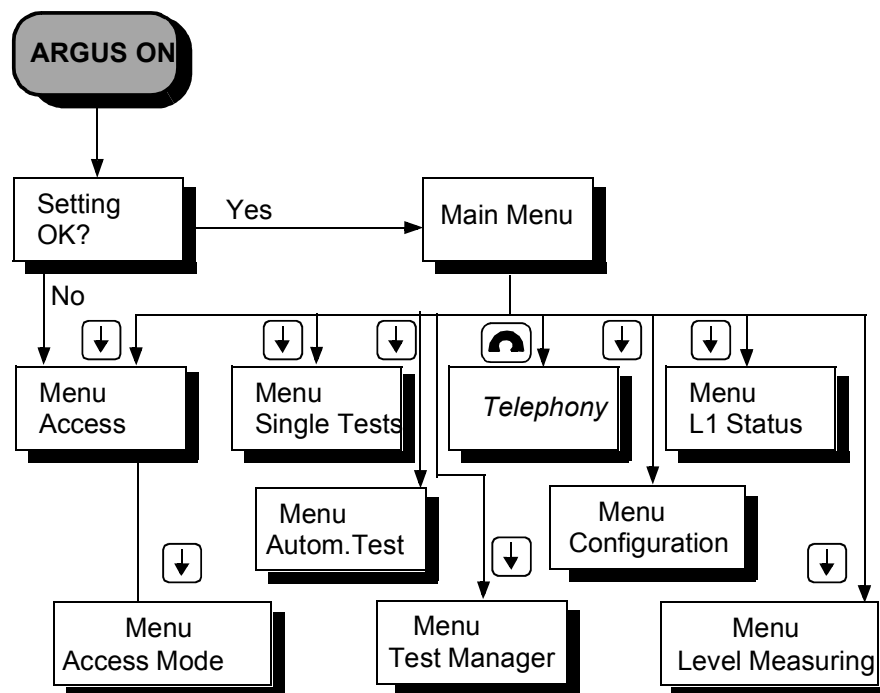

Access Menu

Selection of the physical access:

- **Basic Rate Interface**
- **U Interface**
- **Primary Rate Interface**
- **Analog (a/b) Interface**
- **Automatic**
automatic detection of the interface used
- **Line test**
This tests the terminating resistors for the cabling of a four-wire bus. Additionally, the test also detects errors in the cabling e.g. broken wires, short-circuits and crossed wires.

Access Mode Menu

The *Access Mode* menu opens automatically once the physical access is selected (in the *Access menu*).

Operation on a BRI (S-Bus Access

- **TE Automatic (TE-Simulation automatically)**
- **TE P-P (TE-Simulation point-to-point)**
- **TE P-MP (TE-Simulation point-to-multipoint)**
- **NT P-P (NT-Simulation point-to-point)**
- **NT P-MP (TE-Simulation point-to-multipoint)**
- **S-Bus Monitor**

The ARGUS records all of the D-channel signals and passes them to the serial interface or the infrared interface. Layer 1 will not be actively affected by the monitor function.

- **BRI Recorder**

The ARGUS records all of the D-channel signals on the BRI access and saves them in the internal Flash memory. Layer 1 will not be affected by the Recording function.

- **Permanent circuit**

for telephony, BERT, loopbox

Operation on a PRI Access

- **TE P-P (TE-Simulation point-to-point)**
- **NT P-P (NT-Simulation point-to-point)**
- **PRI Monitor**

The ARGUS captures all of the D-channel signals and sends them to the connected PC via the serial interface or the infrared interface. The bus and Layer 1 will not be affected by the monitoring.

- **PRI Recorder**

The ARGUS records all of the D-channel signals of the PRI access and saves them in the internal Flash memory. The bus and Layer 1 will not be affected by the

recording.

- **Permanent circuit**
for telephony, BERT, loopbox

Operation on a U-interface access

- **TE Automatic (TE-Simulation automatically)**
- **TE P-P (TE-Simulation point-to-point)**
- **TE P-MP (TE-Simulation point-to-multipoint)**
- **Permanent circuit**
for telephony, BERT, loopbox

Operation on an analog access

- **Analog terminal**
- **Analog (a/b) monitor**
High impedance tap without influencing the interface

***Single Tests* Menu**

- **Supplementary Services**
Supports, for 1TR6 (only on a BRI or U-interface access), automatic query of the available supplementary services as well as, for DSS1, manual selection of - and then automatically run - tests of the most important supplementary services.
- **Service tests**
Tests all of the important services by setting up a call to itself. To perform this test completely, there must be at least 2 B-channels available.
- **Bit error test**
Performs a simple bit error test, which can be run as either an extended call to itself, to a loopbox or “end-to-end”.
During the test, the ARGUS shows the bit errors and the remaining measurement time in seconds. The test results, the bit error rate, will be presented in exponential form. Additionally, the results will be

evaluated in accordance with ITU-T G.821 and G.826. With permanent circuits and dialup connections, the same type of BERT can be run simultaneously on the second B-channel of either a BRI or a PRI access.

- **X.31 test**

Performs a X.31 test in the D-channel that checks all TEI values from 0 - 63. The TEIs released for the X.25 service will be shown on the ARGUS.

The ARGUS checks the released TEIs to determine whether there is access to the X.25 network.

- **CF interrogation**

The ARGUS checks whether call diversions are active in the exchange for the access under test (either CFU, CFNR or CFB). All currently setup call diversions will be shown on the ARGUS (maximum of 10) and can, where needed, be deactivated.

- **Connection**

Setup call to the dialed call number. The ARGUS displays the number called, the charges, other information (e.g. SUB, T.o.n etc.) plus the B-channel used.

In the case of the service *Telephony*, the speech channel will be switched over either the integrated handset or an optional headset.

- **Time measurement**

The ARGUS measures the setup time, the propagation time of the data and the transit time differential (interchannel delay).

Test Manager Menu

It is possible to simultaneously and independently run multiple tests (or connections). All of the tests that have been started will be administered by the Test Manager.

Automatic Tests Menu

- **Start**

The ARGUS executes the test(s) automatically.
- **View**

The ARGUS saves the results of several test series and presents the test results on the display.
- **Test data to PC**

The test data saved on the ARGUS will be sent to the connected PC (when WINplus is started). WINplus presents the measured data in a clear test log.
- **Printing**

With a special (optional) cable, it is also possible to print a simplified test report on a Centronics printer.

Settings Menu

- **Trace mode**

The ARGUS passes the recorded D-channel data to the connected PC or saves it in the internal FLASH memory.
- **Insert numbers**

Enter a maximum of ten (24 place) call numbers in the speed dialing memory. The first number in the speed-dialing memory must be the own call number of the access under test. This call number will be needed later for the service test as well as for use in all outgoing calls as your own call number (CGPN or OAD).
- **ISDN**

Settings in ISDN:

 - **L1 permanent?**

Determines, whether Layer 1 should be permanently active for a BRI connection in NT mode.

(only when the ARGUS is operated in NT mode on a BRI access).

- **Protocol**

Manually switch between the 1TR6, DSS1, CorNetN, CorNetT and QSIG protocols.

- **Alerting mode**

Setting to display numbers dialed after an incoming call is setup.

- **Clock mode**

Here, you can select where - regardless of whether in TE or NT operating mode - the clock for the ISDN access is generated.

- **BRI termination**

Options for the terminating resistor for the BRI access regardless of whether in TE or NT operating mode.

- **PRI termination**

Options for the terminating resistor on the PRI access.

- **U-Interface coding**

Options for the coding of the U-Interface:
4B3T or 2B1Q

- **PRI haul mode**

The ARGUS can vary the sensitivity of the PRI:
short haul or long haul

- **Sa5 bits**

Set the Sa5 bits sent (only on a PRI access)

- **Sa6 bits**

Set the Sa6 bits sent
(only on a PRI access)

- **Call parameter**

Two different parameters can be set for a call setup (in ISDN):

- **Type of Number (TON)** for the CGN or CDN element of a SETUP signal
- **Numbering plan (NP)** for the CGN or CDN element of a SETUP signal

- **Call accepted**

Sets, which calls the ARGUS should signal in TE mode on a P-MP access: own MSN or all

- **BERT config.**

Options for the BERT

- **BERT time**

Set the duration of the BERT in minutes.

- **HRX value**

Set the HRX value (hypothetical reference connection see ITU-T G.821)

- **Error level**

Enter the error level for the automatic Good/Bad evaluation of the bit error test

- **Bit pattern**

Selection of the bit pattern used in the bit error test

- **Analog config.**

Options for an analog access

 - **Analog dial**

Specifies the analog dialing mode: DTMF or pulse dialing
 - **Analog CLIP**

Set the transfer procedure used to pass the call number: FSK or DTMF
 - **Analog message**

Specify the display of received messages.
 - **AOC pulse**

Set the country-specific advice of charge pulse used on the analog access (12 or 16 kHz)
 - **DTMF parameter**

The ARGUS can set the parameters *Level*, *Duration* and *Interval* of the DTMF signals generated during analog operation.
 - **FLASH time**

Set the duration of the FLASH time (40 ms to 1 second)

- **ARGUS config.**

Settings for the ARGUS

 - **Menu language**

Select the language to be used in the menus
 - **LCD contrast**

The contrast setting for the display
 - **Date / Time**

Enter the date and time. The time is kept by a built-in real time clock.
 - **Handset**

Select the internal handset or an external headset
 - **Printer**

Setup the printer used for the print function

- Alarm

Activates or deactivates the ARGUS's alarm signal (e.g.in the event of an error)

- Baud rate

Sets the maximum baud rate (used in linking the ARGUS to a PC)

- PC connection

The data can be transferred to the PC via the serial interface or cordlessly via the IrDa interface.

• **Reset**

Resets all of the settings to the original factory (default) settings

***Level Measuring* Menu**

- **Level measurement on a BRI or a U-Interface access**
- **Measures the signal level of a terminal on a BRI**
- **Level measurement on an analog access**
- **Load test of the U-Interface at different levels**

***L1 Status* Menu**

The ARGUS displays the current status of the Layer 1 on a BRI access and the Layer 1 parameter on a PRI access.

Telephony

Simplified telephoning using the telephone key. Pressing the

5 Menu Hierarchy

telephone key twice seizes the exchange line. Once the call number is entered the call will be setup.

6 Menus

6.1 Automatic Access Test

Using the included cable, connect the ARGUS to the access to be tested.

Once the ARGUS is switched on, the starting window will open displaying the access and mode parameters selected last:

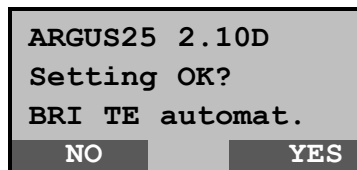

Displayed in the first line:

The software version number: 2.10 (in the example)

Country code: _ (=General), E (=Spain), F (= France), D (=Germany)

Displayed in the third line:

Type of access: BRI, U-interface, PRI or analog

Operation mode: NT = NT Simulation

TE = TE Simulation

perman.swit.

Monitor

Terminal (only with an analog (a/b) access)

Line test

Displayed in the fourth line:

The fourth line displays the current assignment of the three softkeys below.

If you press on "**Yes**" (= softkey on the right), the displayed parameters will be accepted and the ARGUS will be initialized.

The softkey in the middle has no function in this state.

If you press on "**No**" (=softkey on the left), changes to the displayed parameters will be discarded and the Access menu will be opened:

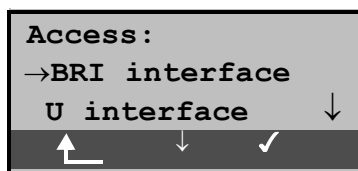

With the ↓ ↑-keys, specify which type of physical access is to be tested.

If “*Automatic*” is selected at this point, the ARGUS will automatically determine the physical access (S-Bus, U-Interface or analog). In this case, the ARGUS sets BRI and U-Interface accesses to TE-mode(see section 6.4.1 page 38).



In this case, the Access Mode menu will not open, therefore functions such as S0-Monitor, S0-Recorder and Permanent Circuit are not available.

The selected type of access will be marked on the left edge of the display with an arrow →. Press the confirmation key or the softkey on the right <✓> to confirm the selected type of access (see section 6.3 Keys page 35).

Alternatively at this point, you can also select the line test and, by pressing the softkey <✓> on the right, directly start it (see section 6.4.2 page 39).

The **Access Mode menu will open automatically** (see section 6.5 page 43).

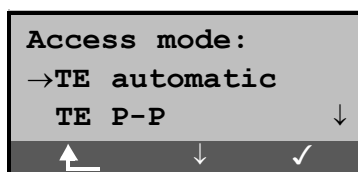

Using the ↓ ↑-Keys, select the desired access mode.

The selected access mode will be marked on the left edge of the display with an arrow → (in the example: TE-automatic).

Press the confirmation key or the softkey on the right <✓> to confirm the selected type of access.

Initializing the ARGUS:

- Operating the ARGUS on a BRI (S-Bus) or U-interface access or operation as a BRI (S₀) NT simulator:

Once the access and access mode parameters have been selected or accepted, Layer 1 will be setup. While Layer 1 is

being setup, the L1 LED above the display will blink. If an error occurs, the message *no Net* will be displayed.

As soon as Layer 1 is successfully setup, LED L1 will light continuously.

When the ARGUS is operated on a U interface, it can take up to 2.5 minutes to activate Layer 1.

As soon as (and as long as) Layer 2 is successfully setup, LED 2 will also light.

If no error occurs, the ARGUS will display the successfully found access and access mode in the third line. Additionally, a qualitative assessment of the level will be displayed.

The ARGUS will, regardless of whether it is in TE or NT mode, automatically determine the protocol and attempt to setup Layer 3 (LED L3 lights). At the same time, the B-channel test will be started and the results will be displayed.

The ARGUS will then idle in the Main menu's status display.

Status display example:

```

ARGUS25 BRI
B12      level: OK
TEs  P-MP  DSS1
      MENU  RESTART
  
```

The test found that it is a BRI multiple device access using the DSS1 protocol.

The bus configuration is displayed in the third line:

P-P = point-to-point

P-MP = point-to-multipoint

In the example both B-channels are available.

B12 both channels are available

B1- only B-channel 1 is available

B-2- only B-channel 2 is available

B-- no B-channel available



If only one B-channel is available, this can have an impact on the service check and the testing of the supplementary services.

In the example, the level is in order (level can only be evaluated on a BRI access):

OK the level is in order
<< the level is too low
>> the level is too high
-- no level

The ARGUS is in TE Slave Mode.

On a bilingual access, the ARGUS uses the DSS1 protocol and thus behaves as a "DSS1 terminal".

You can manually switch the ARGUS to the 1TR6 protocol using the *Protocol* function in the *Configuration/ISDN* menu (see "Select the D-channel protocol" on page 128).

- Using an ARGUS on a PRI Access

As soon as Layer 1 is setup, LED L1 will light continuously. The ARGUS will automatically determine and display, whether or not the PRI access uses CRC4-monitoring.

The ARGUS will begin the automatic detection of the access configuration. After Layer 2 is setup, the L2 LED will also light.

The ARGUS will, regardless of the mode of operation (TE or NT mode), determine the D-channel protocol and attempt to setup Layer 3. At the same time, the B-channel test will also be started.

With the B-channel test, the ARGUS checks the availability of all 30 B-channels by placing an outgoing call on each B-channel one after the other. If the call can be setup, it is assumed that the B-channels are available from both ends.

If the connection is rejected with Cause 44 (see Appendix B), the B-channel will be assumed to be only available for incoming calls.

If the connection is rejected for any other cause, the B-channel will be identified as unavailable. In the case of a cause, which indicates that the B-channel is occupied, the connection will be tried up to two times and, if a connection can still not be setup, it will then be marked as unavailable.

Status display example:

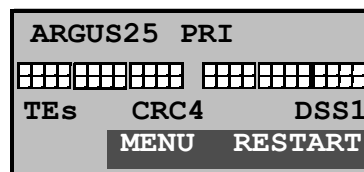

Displayed in the first line:

Type of access: PRI

Displayed in the second line:

Available B-channels: The light squares represent the available B-channels ordered in two blocks of 15. The upper row of squares represent the B-channels that are available for outgoing connections, the lower row represents those that can be used for incoming calls.

left: B-channel 1

right: B-channel 30

Displayed in the third line:

Operation mode: NTs = NT Simulation Slave Mode
 (see "Clock mode" on page 130)
 NTm = NT Simulation Master Mode
 TEs = TE Simulation Slave Mode
 TEm = TE Simulation Master Mode

Layer 1 mode: With (CRC) and without CRC4
 (NoCRC)

D-channel protocol: 1TR6, DSS1, none, BILINGUAL, Auto,
 CorNet-N, CorNet-T, QSIG

Displayed in the fourth line:

The ARGUS displays the current assignment of the three softkeys below.

Test sample:

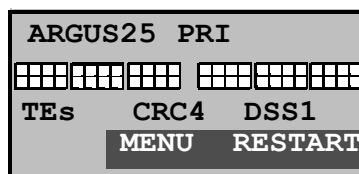

- The test found that it is a PRI multiple device access using CRC4-monitoring and the DSS1 protocol. All 30 B-channels are available and can be used for outgoing or alternating connections.

The B-channel test cannot distinguish between alternating and exclusively "outgoing" B-channels.

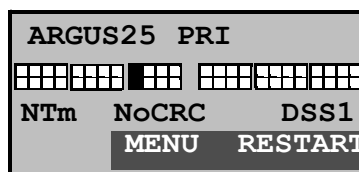

- The ARGUS is in the NT-Simulation Master mode and is connected to a terminal using the D-channel protocol DSS1 without CRC4-monitoring. B-channel 11 is not available.

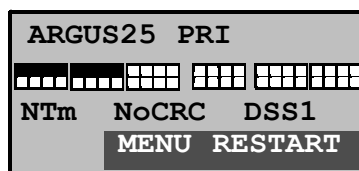

- The first 10 B-channels are configured in the exchange as incoming channels only (seen from the viewpoint of the terminal), while B11-B30 can be used for outgoing or alternating connections.

```
ARGUS25 PRI
      no Net
      TEs
      MENU RESTART
```

- The ARGUS is not properly connected (e.g. wrong cabling) or the network is not in order.

- Operating the ARGUS on an analog access

The following will be displayed:

```
ARGUS25 a/b
      MENU RESTART
```

6.2 Status display

The ARGUS automatically determines the configuration of the access and the protocol used and inserts both parameters in the remaining tests. Thus manual configuration of the ARGUS is unnecessary. However, it is possible to manually change the protocol using the *Configuration* menu (see section 6.9.2.2 Select the D-channel protocol page 128).

The status of the access under test (PRI, U interface, BRI or analog) is always displayed in the first line.

It must be mentioned again, that the ARGUS only determines the general bus status once – automatically when switched on or when the ARGUS first connected.

On the other hand, the status of the protocol stacks for Layer 1, 2 and 3 will be continually monitored and displayed.

To repeat the B-channel test, press the <RESTART> softkey on the right.

If the test cannot be executed without errors (e.g. because the access was unplugged), the ARGUS will, depending on the class of error (see “Suppl. Services Tests – Error messages” on page 91), reinitialize or show an error message.

If you press the <MENU> softkey, the ARGUS will return the Main menu.

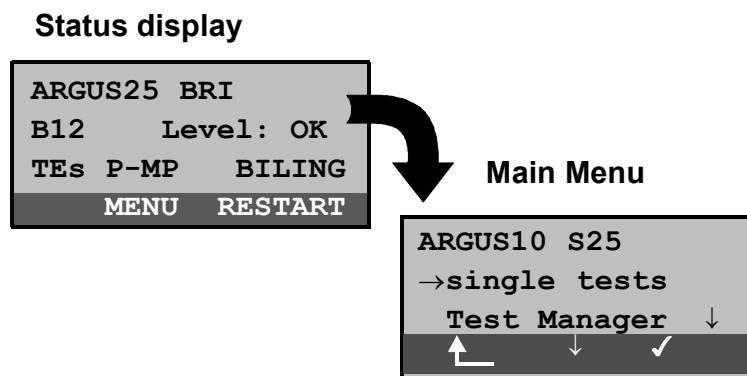

6.3 Keys

The ARGUS is in largest part operated with the two ↓ ↑ - Keys, the confirmation key ✓ and the three softkeys.

In the status display, the <MENU> softkey will return the ARGUS to the Main menu, which includes of a list of all of the available menus.

In the remaining manual, the softkeys are represented by their respective labels placed in brackets < >, thus in the sample above the softkey would simply be <MENU>.

The < ✓ > softkey serves the same function as the ✓ confirmation key and the < ↓ > softkey performs the same function as the corresponding arrow key on the ARGUS keypad.

Once the list is open, you can scroll through the available menus with the < ↓ > Key:

- **Single tests**
- **Test Manager**
- **Automatic test**
- **Level measuring**
- **L1 status**
- **Configuration**
- **Access**

A ↓ displayed after a menu indicates that this menu has further entries, which can be scrolled through using the < ↓ > Key.*.*

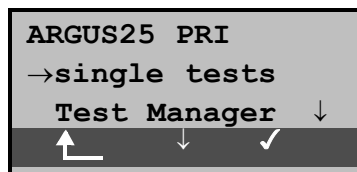

With the < ✓ >, you can open the menu currently marked with the → (in the sample *Single tests*).

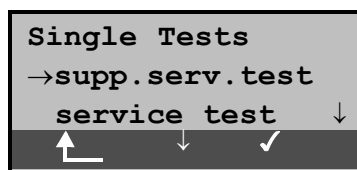

The name of the currently opened menu will be displayed in the first line. Below this are the available functions. A ↓ on the right side of the display indicates that you can scroll

through additional functions with the <↓> Key.

With the <✓>, you can open the menu currently marked with the → (in the sample *Single tests*).

With ↶ you can jump from the current display back to the previous level.

Using the digit keys, you can start important ARGUS functions directly, regardless of the currently active menu level.

Number 2 Key Start Service check

Number 3 Key Start Supplemental service test

Number 4 Key Start Auto. Test

Number 6 Key Start Test Manager

Number 7 Key Entry of your own and remote
call numbers in the speed dialing memory

Number 8 Key Trace ON/OFF

Number 9 Key Start Bit Error Rate Test (BERT)



If a function is called where the ARGUS expects the entry of a digit, pressing a number key will be interpreted as the expected input.

6.4 Menu: Access

Opening the Access menu:

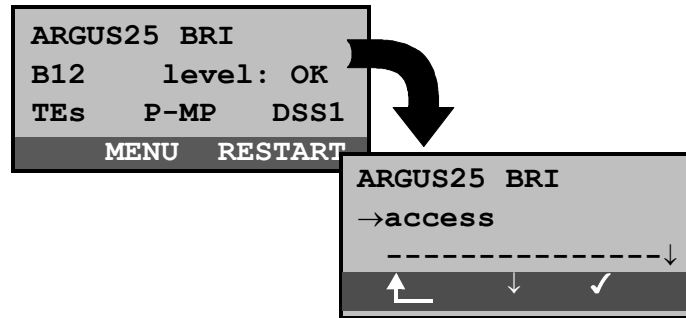

	Operation
<RESTART>	Repeat B-channel test
< MENU >	Open the <i>Main menu</i>
< ↓ >	Select the <i>Access menu</i>
< ✓ >	Open the <i>Access menu</i>
↶	Return to the status display

Throughout the remaining manual, under each display, you will find a table that describes the operation of the ARGUS in the current situation.

On the left side of the table, you will find all of the ARGUS keys that are available for the user to press in the current state (e.g. ↓ for the ↓ Key or < ↓ > for the corresponding softkey).

On the right side of the table, you will find an explanation of the function of each key in this context.

1
2
3
means that at this point the ARGUS expects the user to enter data on the numeric keypad

4
5
6

7
8
9

*
0
#

6.4.1 Selection of the physical access

In the Access menu, the user must select the type of physical access to which the ARGUS is connected. When the ARGUS is restarted, the settings used last will be suggested as the default.

If **Automatic** is selected, a fully-automatic process will be started: The ARGUS will automatically recognize a BRI, PRI, U_{interface} or analog access. In the case of a BRI or U interface access, the ARGUS will be set in the TE mode and the access mode (PP or P-MP) will be determined automatically. When the ARGUS finds a PRI access, it will enter the TE mode PP.

The ARGUS will determine which D-channel protocol is used on the BRI, PRI or U interface access and perform the B-channel test. After the level was measured (only for an ARGUS 22 on a BRI access) the ARGUS will return to the Main menu.

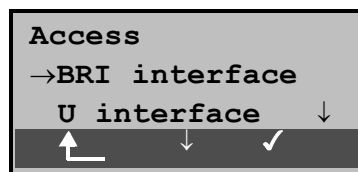

< ↓ >

< ✓ >



Operation

Select desired access

Confirm

When the BRI, U interface, PRI or analog interface is selected, the Access Mode menu will open automatically.

Return to Main menu

6.4.2 Line test

The ARGUS tests the terminating resistors for the cabling of a four-wire bus. Additionally, the test also detects errors in the cabling e.g. any broken wires, short-circuits and crossed wires.



Unplug the NT and all terminal equipment from the bus, before performing a line test!

If the ARGUS detects an operator error (Line test on a fed bus), it will emit a continuous acoustic signal. In this case, to prevent the destruction of the ARGUS, the line test will **not** be started.

Test sequence:

To perform a thorough test of the lines, the test must be done in 2 steps.

First step:

Use the test adapter to connect the ARGUS to the lines to be tested. In this step, the ARGUS will determine whether or not there is a short circuit or a terminating resistor and whether there is a fault between the terminating resistor – if there is one – and the test adapter.

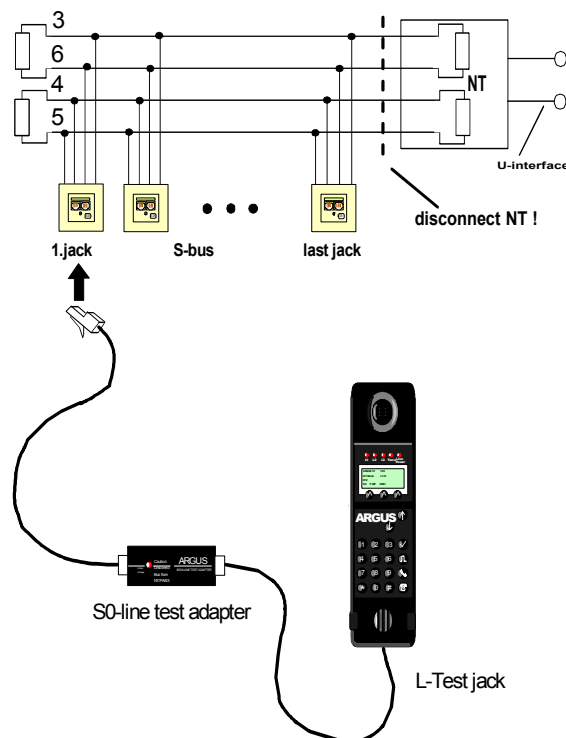

Possible test results:

- The ARGUS has detected a short-circuit: Clear the fault and repeat the test
- The ARGUS reports that the resistance is wrong: Repeat the test from another socket, if necessary remove the terminating resistor(s)
- The ARGUS reports that the line is OK: Continue test with step 2

Second step:

Connect the test adapter to the jack, which was tested as OK in the first step. Connect the ARGUS via its *L-Test* connector to the next jack on the bus.

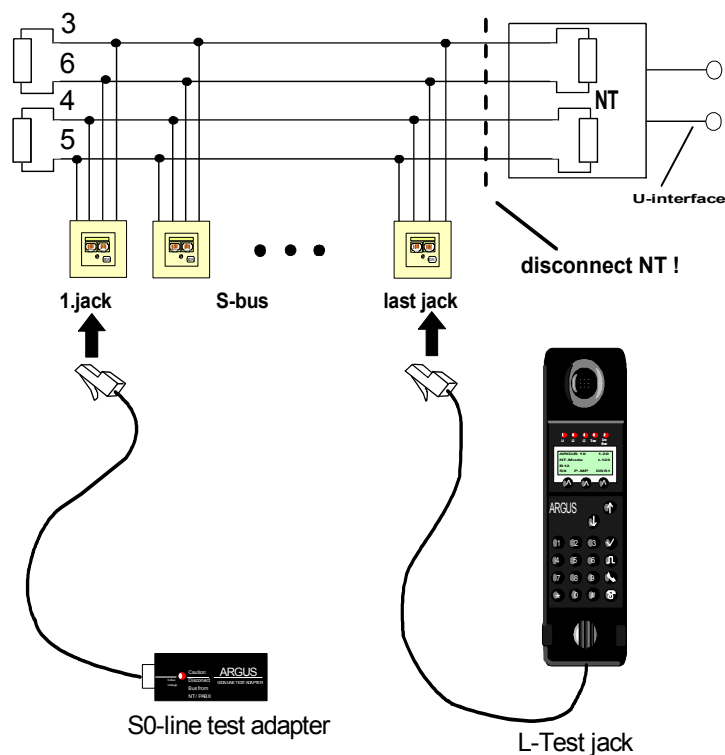

Possible test results:

- The ARGUS reports broken connections or crossed wires: Clear the fault and repeat the test beginning with the first step.
- The ARGUS reports that the line is OK: Connect the ARGUS (L-Test jack) to each of the sockets on the bus one after the other.

Test steps on the ARGUS:

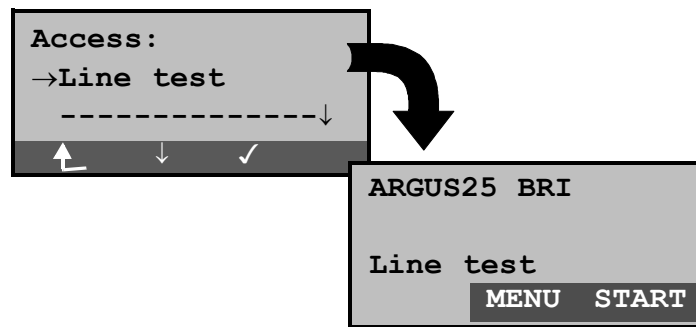
**Operation**

< **MENU** > Opens a list with the following menus: Access, Automatic Tests, configuration, start L-test and level measuring.

The *Autom. Test* menu only has functions for displaying measurement data and transferring it to a PC. In this menu, you cannot start an automatic test series (see section 6.8.1 Starting the Automatic Test page 119).

< **START** > **Start the Line test**

Sample test results – Line test:

```
Line test
Circuit OK
Termination 100Ω
ABORT NEW
```

No errors occurred.

```
Line test
Crossed wires:
                 3><6
ABORT NEW
```

Wires 3 and 6 are crossed.



If the message “crossed wires: termination wrong” appears, the measurement conditions with respect to the location of the fault or to the complexity of the fault are unfavorable.

In this case, you should change the measurement conditions in the following manner:

Remove the terminating resistors from the bus and repeat the test.

Frequently it is enough to simply swap the test adapter and the ARGUS.

Comments about the test results:

- The bus can first be considered to be free of defects, when all of the sockets have been tested as OK.
- Short-circuits are reported as a resistance value $< 10 \Omega$.
- Crossed wires and broken connections between the test adapter and the terminating resistor cannot be found.
- The displayed test results are either for just the bus lines between the ARGUS and the test adapter in the case of cross-wires and broken connections or for the entire bus in the event of short-circuits and terminations.

6.5 Menu: Access mode

The Access mode menu is **not** selectable from the Main menu. It opens automatically once the physical access is selected in the Access menu.

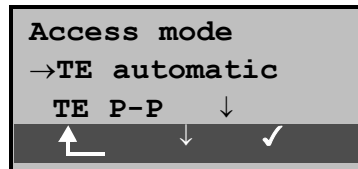

< ↓ >

< ✓ >



Operation

Select the desired *mode*.

Confirm

Return to the *Access* menu

6.5.1 Operation on a BRI or a PRI access

The following settings are possible:

6.5.1.1 TE-Simulation mode

TE automatic

On a BRI access, the access mode (PP or P-MP) will be determined automatically. The ARGUS will then jump to the Main menu.

TE P-P or TE P-MP

Afterwards, the access and the protocol stack will be initialized in accordance with the selected setting. When the ARGUS finds a PRI access, it will enter the TE P-P mode.

The ARGUS will then jump to the Main menu.

6.5.1.2 NT-Simulation mode P-P or P-MP

NT P-P or NT P-MP

Afterwards, the access and the protocol stack will be initialized in accordance with the selected setting. When the ARGUS finds a PRI access, it will enter the TE P-P mode.

The ARGUS will then jump to the Main menu.

6.5.1.3 Permanent switch

Besides dial-up connections to any subscriber, ISDN also supports the use of permanent circuits switched to a specific remote location.

These permanent circuits are available after setting up Layer 1, in other words after synchronizing both terminals by exchanging HDLC-frames.

The location where the clock is generated can be selected on the ARGUS(see section 6.9.2.4 Clock mode page 130).

As a quick test of a permanent circuit, you can simply call the opposite end using a selected B-channel. However, for a more revealing test of a permanent circuit, you should perform a bit error rate test.

Both ends of the permanent circuit must use the same channel.

■ Telephony on permanent switches

The function can be started with the -Key or via the selection *phone / connec.* in the *Single tests* menu (see section 6.6.1 page 63).

After the B-channel for the permanent circuit is selected, the telephone connection will be setup automatically.

```
Permanent switch
Telephony      B01
Durat.        13:45:59
ABORT
```

<Abort (on
hook) >

< TM >

Operation

Terminate permanent circuit

Call the Test Manager (see "Menu: Test Manager" on page 110)

Besides the function Telephony, the ARGUS also shows the B-channel used (second line in display) and the duration of the permanent circuit (third line).

■ BERT on permanent switches

A number of variations are possible in testing permanent circuits with the bit error rate test.

In the simplest case, a B-channel loop will be set up at the remote end.

After selecting *BERT start* (menu *Single tests* / submenu *Bit error test* / function *BERT start*: see “*BERT start*” on page 97) and selection of the channel to be tested (B-channel or D-channel), the ARGUS will send the test pattern, receive it back and evaluate it accordingly.

The display during and after the bit error rate test as well as the operation are in largest part similar to that of a BERT with dial-up connections (see section 6.6.6 Bit error test page 95). The only difference is that it is not necessary to select a call number or service.

In the case of a BRI₀- or a PRI access in end-to-end mode (see “Bit error test” on page 95 and on page 102 “Bert wait”), it is also possible to run a BERT in the D-channel.

In this case, a *channel select* window will open:

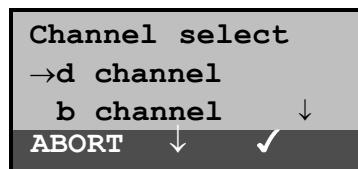

Operation

- | | |
|----------|--|
| < ↓ > | Selecting a <i>channel</i> |
| < ✓ > | Confirm the selected channel and start the test.
When selecting a <i>B-channel</i> , the <i>B-channel select</i> window will open to allow you to choose the desired B-channel. |
| <ABORT > | Close window and discard any selection that was made |

The ARGUS displays the following during the test:
the channel used: D for B-channel
the remaining test period in hours:minutes:seconds:
24min:12sec
the number of bit errors that have occurred: 00002
the synchronicity of the bit pattern: Synchronous

```
BERT          D
00:24:12     00002
Synchronous
ABORT  TM   ERROR
```

Operation

< ERROR > Injects an “artificially generated” bit error (to check the reliability of the test)

< TM > Call the Test Manager (see “Menu: Test Manager” on page 110)

<ABORT > Test - interrupting

■ Loopbox on permanent switches

It is possible to activate a loopbox (see “B-channel loop” on page 103).

On a BRI access, the loopbox is permanently setup for both B-channels but **not** for the D-channel; on a PRI access it is also permanently setup to loop back the D-channel.

```
Permanent switch
Loopbox active
Durat.    13:45:59
ABORT
```

Operation

<ABORT > End loopbox activation

The ARGUS shows how long the loopbox has been active on third line in the display.

6.5.1.4 BRI/PRI Monitor

The ARGUS accepts all of the D-channel signals from the BRI or the PRI access and sends these D-channel signals over the serial interface or via the IrDa interface to a PC which must be running ARGUS WINplus or WINAnalyse. The bus and Layer 1 are not influenced by the monitoring.

```

ARGUS25 BRI
level OK
monitor
MENU START

```

Display during operation on a BRI access:

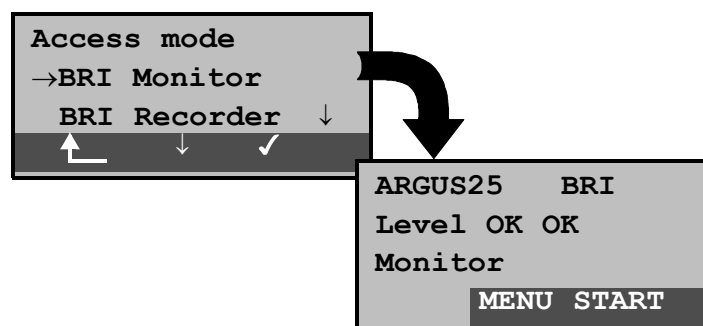

```

Access mode
->BRI Monitor
  BRI Recorder ↓
  ↑ ↓ ✓

```

```

ARGUS25 BRI
Level OK OK
Monitor
MENU START

```

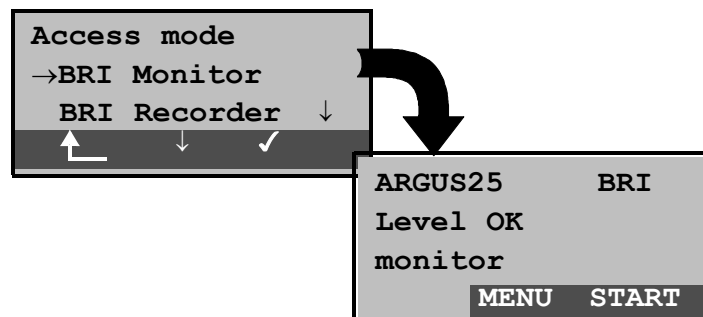

```

Access mode
->BRI Monitor
  BRI Recorder ↓
  ↑ ↓ ✓

```

```

ARGUS25 BRI
Level OK
monitor
MENU START

```

After starting the *Monitor* function, the ARGUS will first be in Monitor mode (the monitor is not yet active): the second line shows the evaluation of the level on the NT-side (first OK or << (too low), >> (too high), _ (no level) and TE-side (second OK).

Display during operation on a PRI access:

```
ARGUS25 PRI
Monitor
MENU START
```

Operation

< **MENU** > Opens a list with the following menus:
Start Monitor, Access, Automatic. Tests, Configuration, Level measuring and L1 status.

The *Autom. Test* menu only has functions for displaying measurement data or transferring it to a PC. In monitor mode, you cannot start an automatic test series (see section 6.8.1 page 119).

The Level measuring submenu is not available when the PRI monitor is in operation. In the BRI Monitor, the submenu L1 status is not available.

< **START** > **Start Monitor**, automatically opens the associated display window

```
Monitor
Signals:      25
Time:        00:02:59
ABORT
```

< **ABORT** > Deactivate the function and return to the "Monitor mode" display (not active)



While the PRI Monitor is active, the ARGUS displays the L1 status (see L1 status in PRI Monitor Mode)

When the monitor function is active, the ARGUS counts the number of incoming signals and presents this number in the second line of the display. The amount of time that has passed since the monitor was started is displayed in third line. The Trace LED is on.

The recorded D-channel signals will be sent via the serial interface or the IrDa interface to the PC, which must be running either ARGUS WINplus or ARGUS WINAnalyse.

ARGUS messages on a PRI access

As soon as a change occurs, the ARGUS will send a time-stamped report of the following alarms/states to the PC, which will evaluate them:

- *Signal*
- *FAS*
- *CRC4det*
- *A-Bit*
- *AIS*

The ARGUS will check the following values and counters every second and, in the event of a change, will pass them on the PC:

- *Sa5-Bit (Rx)*
- *Sa6-Bit (Rx)*
- *E-Bit*
- *Ecnt*
- *CRC Err.*
- *Cod.Err.*
- *Frem.Err.*

■ Parallel call display in the BRI Monitor mode

When the monitor mode is active, the ARGUS will search all of the D-channels signals sent for a SETUP. As soon as a SETUP is found, the **CALL** softkey will appear in the monitor window.

```
Monitoring
Signals:      25
Time:        00:02:59
ABORT        CALL
```

```
N->U          FaxG3
125670        B01
to: 02351901720↓
ABORT        SIGNAL
```

Operation

< CALL >

The ARGUS displays the data for the call (incoming or outgoing). The ARGUS will automatically process the last SETUP received.

In the first line of the display, you will find the call direction (**Net -> User**, or **User -> Net**) and the service (in the example *FaxG3*). In the second line, your own call number (in the example *125670*) and the B-channel used (here: *1*) will be displayed. The destination number is displayed in the third line.

	Operation
<↓>	The sub-address, User-User-Info, DSP messages (if existent), Type of number (T.o.n) and Numbering Plan (NP) will be displayed in this order.
<ABORT >	Once you leave the <i>Parallel Call Display</i> function, the ARGUS will be in the Monitoring (not active) mode.
<Counter >	The ARGUS switches to the active Monitor window. Now, if you press <CALL>, the ARGUS will again display the call parameters.

■ L1 status NT in the PRI Monitor mode

The L1 status NT function is only available in the PRI Monitor mode. The Layer 1 alarms and messages are presented in several windows, which permit detailed statements regarding the state of the PRI access and the transmission line (For further information, see the CCITT/ITU guidelines G.703 and G.704).

When the function is started, it will first automatically open the “L1 status TE” function, which shows the “TE-side parameter”. For a comprehensive explanation of the displayed information: see “The L1 status of a PRI access” on page 176.

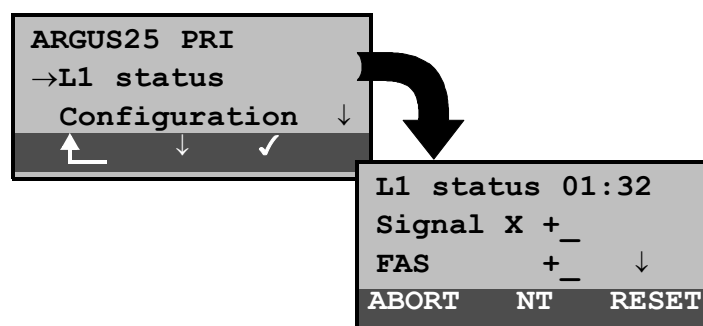

	Operation
< ↓ >	Select <i>L1 status</i>
< ✓ >	Open the <i>L1 status</i> function
↶	Return to the <i>Monitor Mode</i> window
↓ -Key	Scroll through the display
< NT >	Switch to the “L1 status NT” function; the “NT-side parameter” will be displayed
< RESET >	Reset the History function and all counters
< ABORT >	Quit the function and return to the menu list

6.5.1.5 BRI/PRI Recorder

In the Recorder mode, the ARGUS passively monitors the connected BRI or PRI access.

The ARGUS records all of the D-channel signals sent in both directions without affecting the access or Layer 1.

Unlike in the Monitor mode, the recorded D-channel signals

will be saved in the ARGUS's internal FLASH memory and not sent to a PC.

The storage is organized as a ring buffer, i.e. as soon as the FLASH memory is full, the ARGUS will automatically overwrite the oldest data.

Display when operated on a BRI access:

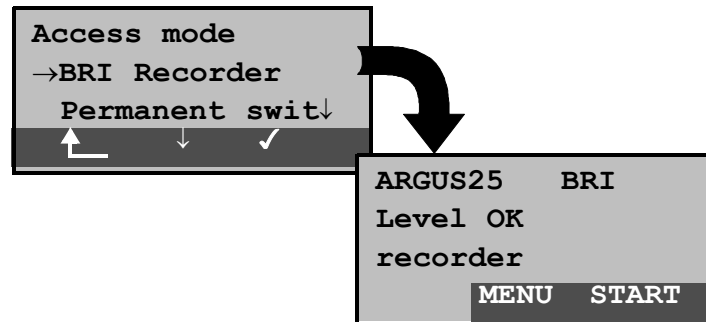

Display when operated on a PRI access:

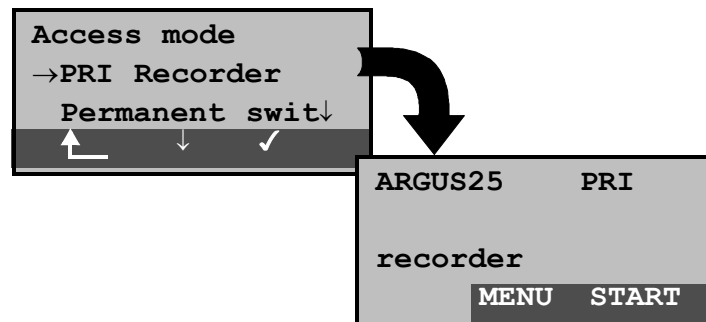

Operation

< ↓ > Select the *BRI Recorder* or when testing a PRI access the *PRI Recorder* .

< ✓ > Start the *BRI Recorder* function.
 The ARGUS is now in the "Recorder" mode (Monitoring is **not** yet active!) and will check the levels on the NT and TE sides of the BRI access. Displayed in the second line: Level on the NT-side (<< too low, >> too high, OK, ___ no level), level on TE-side (<< too low, >> too high, OK, ___ no level)

⏪ Return to Main menu

< MENU >	Opens a list of the available functions and menus: Start Recording, PC load all, PC load session, Reset Flash, Info Flash, Autom. Tests, Level measuring, L1 status, Configuration and Access.
< START >	Start Recording , automatically opens the associated display window

The *Autom. Test* menu only has functions for displaying measurement data and transferring it to a PC. In this menu, you cannot start an automatic test series(see section 6.8.1 page 119).

The Level measuring menu is not available when the PRI Recorder is in operation.

In the BRI recording mode, the L1 status menu is not available.

■ Active Recording Function

When the Recording function is active, the *Trace* LED will flash. The ARGUS displays the number of signals received and the duration of the recording in hours:minutes:seconds. Operation on a BRI access:

Recording	BRI
Signals:	23
Time:	00:12:54
ABORT	

During the recording, the ARGUS also displays incoming and outgoing calls (see “n Parallel call display in the BRI Monitor mode” on page 49).

Operation on a PRI access:

```
Recording    PRI
Signals:    23
Time:      00:12:54
ABORT
```

Operation

< ABORT >

Quitting the active recording function. The ARGUS is now in the "Recording" mode.

As soon as an event occurs, the ARGUS will send a time-stamped report of the following alarms/states to the PC, which will evaluate them:

- *Signal*
- *FAS*
- *CRC4det*
- *A-Bit*
- *AIS*

The ARGUS will check the following values and counters every second and, in the event of a change, will pass them on the PC:

- *Sa5-Bit (Rx)*
- *Sa6-Bit (Rx) / (Tx)*
- *E-Bit*
- *Ecnt*
- *CRC Err.*
- *CRC rel.*
- *Cod.Err.*
- *Cod.rel*
- *Frm.Err.*

■ Flash Data Management

In the Recording mode, several functions are available to manage the data recorded and saved in the FLASH memory:

- *PC load all*
- *PC load session*
- *Reset Flash*
- *Info Flash*

• ***PC load all***

With the *PC load all* function, all of the contents of the Flash memory will be downloaded via the serial or IrDa interface to

the PC, which must be running either WINplus or WINanalyse.

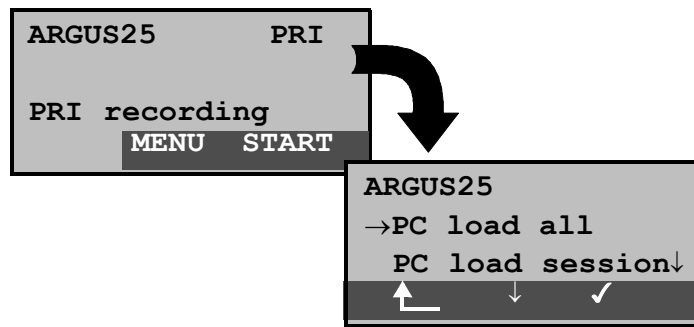

Operation	
< MENU >	Calls up the functions (or submenus) that the ARGUS supports in Recording mode.
< ↓ >	Select <i>PC load all</i>
< ✓ >	The download to the PC begins.
	Return to the not active Recording mode

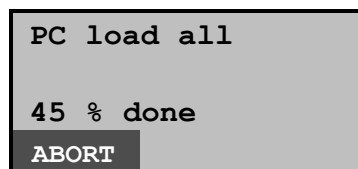

Operation	
< ABORT >	The download is stopped. Return to the menu.

Once the loading is successfully completed, the following display will open automatically:

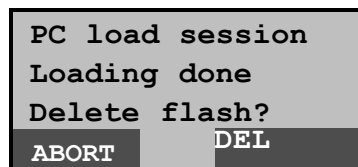

Operation	
< DELETE >	The contents of the FLASH memory will be deleted.
< ABORT >	The contents of the FLASH memory will not be deleted. Return to the menu.

- **PC load session**

In the ARGUS, the storage in the internal Flash is organized as a ring buffer, which can hold the data from a series of several sessions (i.e. independent trace recordings). At the start of each session, the date and time will be written as a string in the ring buffer.

The *PC load session* function transfers all of the data session-by-session to the PC on which either WINplus or WINanalyse must be running. The time and date that the session was started will be displayed in WINplus/WINanalyse.

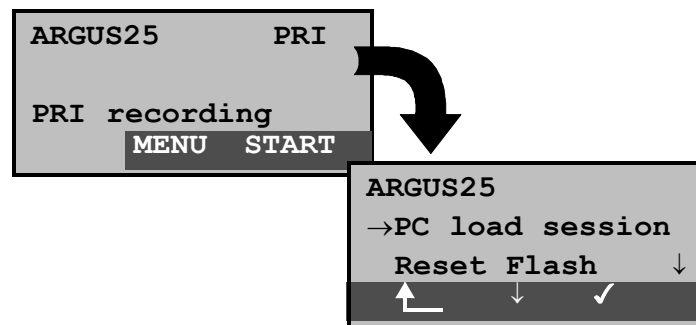

Operation	
< MENU >	Calls up the functions (or submenus) that the ARGUS supports in Recording mode.
< ↓ >	.
< ✓ >	The loading of the individual sessions will start.
↶	Return to the not active Recording mode

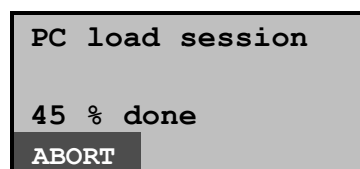

Operation	
< ABORT >	Stop loading the session. Return to the menu.

After a session is transferred, the following will be displayed:

```

PC load session
Session done
Another session?
ABORT      CONT.
  
```

Operation

< CONT.> The next session will be downloaded to the PC.

< ABORT> Stop the loading and return to the menu.

Once the loading is successfully completed, the following display will open automatically:

```

PC load session
Loading done
Delete Flash?
ABORT      DEL
  
```

Operation

< DELETE> The contents of the FLASH memory will be deleted.

< ABORT> The contents of the FLASH memory will not be deleted. Return to the menu.

- **Reset Flash**

The *Reset Flash* function will delete the contents of the data Flash memory at any time.

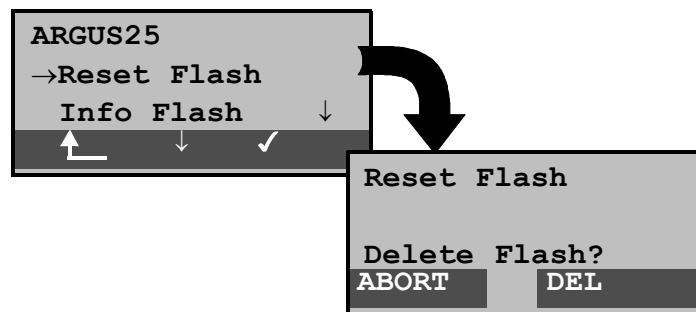



	Operation
< ↓ >	Select <i>Reset Flash</i>
< ✓ >	Start the <i>Reset Flash</i> function
	Return to the not active Recording mode
< DELETE >	The contents of the FLASH memory will be deleted. The procedure can take several seconds. The ARGUS will show the progress of the deletion as the percentage done. It is not possible to stop the process of deletion. As soon as the entire FLASH memory is erased, the ARGUS will automatically return to the next higher menu.
< ABORT >	Return to the menu; the contents of the FLASH memory will not be deleted.

- **Info Flash**

Using the *Info Flash* function, you can check the status of the data in the FLASH memory:

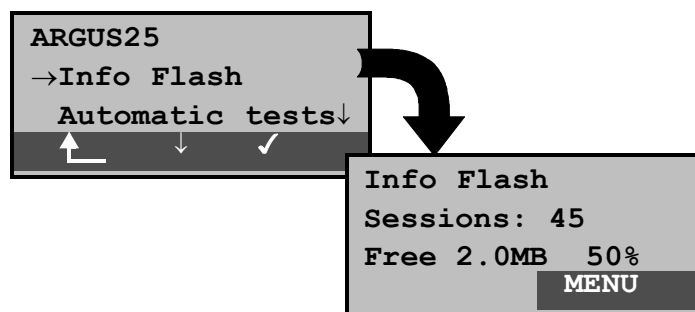
- The number of saved sessions
(displayed in the second line)
- Free memory in MB and in percent
(displayed in the third line)



	Operation
< ↓ >	Select <i>Info Flash</i>
< ✓ >	Call up information about the status of the data in the Flash memory.
	Return to the not active Recording mode.
< MENU >	Continue to the menu

6.5.2 Operation on a U interface access

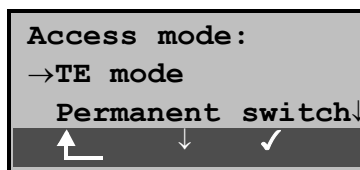

6.5.2.1 TE-Simulation mode

TE automatic

The ARGUS automatically determines the access mode (PP or P-MP). The ARGUS will then jump to the Main menu.

TE P-P or TE P-MP

Afterwards, the access and the protocol stack will be initialized in accordance with the selected setting. The ARGUS will then jump to the Main menu.

6.5.2.2 Permanent circuit

similar to that with a BRI or PRI access

6.5.3 Operation on an analog access

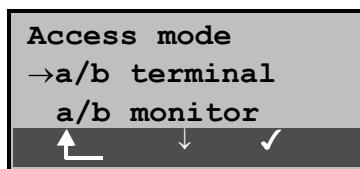

6.5.3.1 a/b terminal

The ARGUS behaves like an a/b (analog) terminal. The ARGUS will then jump to the Main menu.

6.5.3.2 a/b monitor

Essentially, the a/b (analog) monitor provides a high impedance tap that does not influence the interface. You can listen to the line with the integrated handset without having the ARGUS send on or otherwise influence the interface.

```

ARGUS25 a/b
monitor
MENU  START

```

Operation

- < **MENU** > Opens the menu list:
Access, Automatic Tests, Configuration, Level and Start Monitor.
The *Autom. Test* menu only has functions for displaying measurement data and transferring it to a PC. In this menu, you cannot start an automatic test series(see section 6.8.1 page 119).
- < **START** > **Start Monitor**, automatically opens the associated display window

```

Monitor analog
02351907070
DTMF: 2346578 ↓
ABORT  DEL

```

Operation

- ↓-Key Display further information
(e.g., transferred charges)
- < **DELETE** > The display will be cleared.
- < **ABORT** > Quits the *Monitor analog* function.

If the access supports CLIP, the caller's number will be displayed on the second line.

The DTMF-characters dialed by both telephone subscribers will be displayed on third line.

Any additional DTMF-characters will be appended to the line, which will shift left for each character once it is full.

An incoming call will be signalled acoustically.

6.6 Menu: Single Tests

Opens the Singletest menu:

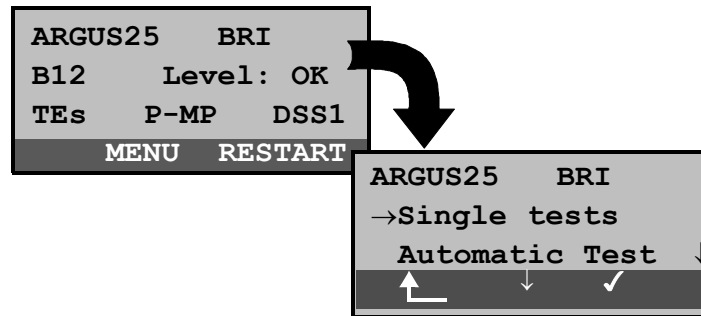

	Operation
<RESTART>	Repeat B-channel test
< MENU >	Open the <i>Main menu</i>
< ↓ >	Select the <i>Single tests</i> menu
< ✓ >	Open the <i>Single tests</i> menu
↶	Return to the status display

Open the functions in the Single tests menu:

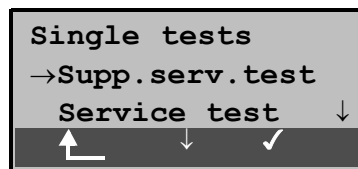

	Operation
↶	Return to Main menu
< ↓ >	Mark the desired function
< ✓ >	Open the function marked with the →

6.6.1 Connection

6.6.1.1 Setting up an ISDN connection

- a) The ARGUS can setup a connection for the following services:
- Tel. analog
 - Tel. ISDN (3.1 kHz)
 - Tel. 7kHz
 - Voice
 - 7kHz Audio
 - Videotext
 - Fax G3
 - Fax G4
 - UDI 64kBit/s
 - Teletext
 - Video conference 1
 - Video conference 2
- b) In the case of a telephone connection, you can either use the integrated handset or attach an optional external handset.
- c) When an ISDN connection is setup, pressing the number keys (0-9) or the * or # will generate and send the corresponding DTMF tones.

■ Procedure outgoing call (ISDN)

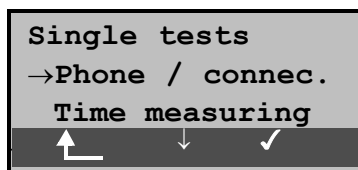

	Operation
< ↓ >	Select <i>phone / connec.</i>
< ✓ >	Confirm the selection and the <i>Enter numbers</i> window will open
⬆	Return to Main menu
Alternative: ☎-Key	Regardless of the currently active menu level, the ARGUS will begin to setup a connection. The window, <i>Enter numbers</i> , will now open.





- **Select or enter a call number**

The *Enter numbers* window will open automatically. Here you can choose between overlap and en-bloc signaling. When overlap signaling is chosen, the digits will be individually dialed as the number keys are pressed. In en-

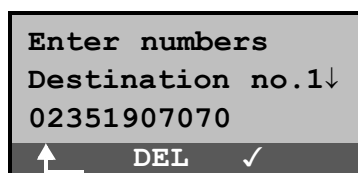
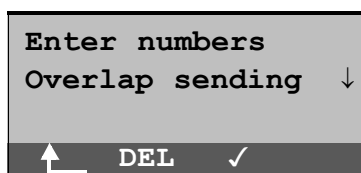
block signaling, the complete dialing information will be sent in one block.

Display for en-bloc signaling:



<p>< ✓ ></p> <p>or</p> <p>-Key</p> <p></p> <p>↓-Key</p> <p>< ↓ ></p> <p></p> <p>< DEL ></p> <p></p> <p>< ✓ ></p> <p>or</p> <p>-Key</p>	<p>Operation</p> <p>Select <i>Overlap</i></p> <p>Overlap is used as the default to permit the simplest access to the dialing tone</p> <p>In the case of overlap signaling, the <i>Select service</i> dialog opens immediately. Select the entry mask <i>Select service</i> and the <i>B-channel select</i> will be skipped. The ARGUS will immediately display the <i>Outg.call</i> window.</p> <p>Return to the <i>Single tests</i> men</p> <p>Select en-block: The speed-dialing memory, which can be used to store and dial your own plus up to 8 other call numbers, will open automatically (see “Saving Call Numbers” on page 165).</p> <p>Only with en-bloc signaling:</p> <p>Scroll to the desired call number</p> <p>or</p> <p>enter the new call number.</p> <p>Delete individual digits</p> <p>Return to the <i>Single tests</i> menu</p> <p>The <i>Select service</i> window opens</p> <p>Select the entry mask <i>Select service</i> and the <i>B-channel select</i> will be skipped. The ARGUS will immediately display the <i>Outg.call</i> window.</p>
--	--



The extension is separated from the access number by a #. For an outgoing call, the ARGUS uses the entire call number (without #) as the number called (CDPN or DAD) and, for the calling number, only the extension (DSS1-CGPN or 1TR6-OAD).

A "#" at the beginning of a call number is treated as a valid character. A '#' at the end of the own call number instructs the ARGUS to not send the caller's number for outgoing calls (CGPN or OAD).

An example:

02351 / 9070-20 is entered as 023519070#20.

Call numbers can be deleted digit for digit with the < DEL>-Key (DELeTe).



Simplified overlap signaling using the telephone key:

Regardless of the currently open menu, you can quickly and easily place a call: press the telephone key twice. The ARGUS will jump to the Overlap/Connect function (in the Single tests menu). Press the telephone-key again (you will hear the dialing tone). The call number can now be entered and dialed digit-by-digit. The connection will be setup.

- **Select service**

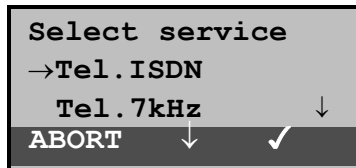

< ↓ >

< ✓ >

<ABORT >

Operation

Select the *Service*

Confirm the *Service* selected and the *B-channel select* entry dialog will open

Return to the *Single tests* menu

- **B-channel selection**

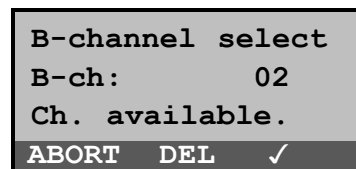

< DEL >

< ✓ >

<ABORT >

Operation

Enter the *B-channel* (by default, the last *B-channel* used will be suggested) if you enter an *, a *B-channel* that is free will be selected.

Delete the *B-channel* digit-by-digit

Confirm your selection and the *Outg.call* window will open

Return to the *Single tests* menu

In the third line, the ARGUS will indicate whether the selected *B-channel* is available on the access being tested.

- **Connection**

```

Outgo.call  Tel.
90700      B02
to: 01191
ABORT

```



<ABORT >

Operation

In overlap signaling mode, the call number can only be entered and dialed digit-by-digit (third line)

Return to the *Single tests* menu

Example display:

First line: Service: *Telephony* (TEL.)

Second line: *Own number* (90700),
B-channel used (B02)

Third line: *Number dialed* (01191)

The connection is setup on B-channel 2 status:

```

Connect.    Tel.
90700      B02
to: 01191  ↓
ABORT     TM

```

↓ -Key

< ABORT >

< TM >

Operation

Display additional call data,
e.g., charges

Disconnect
Return to the *Single tests* menu

Call the Test Manager (see “Menu: Test Manager” on page 110)

- **Display additional call data**

If the ARGUS displays a ↓ on the right on the third line, additional information can be viewed by simply pressing a button (τηε ↓-key):

- **Subaddress**

The sub-address of the caller (second line) and the dialed sub-address will be displayed.

```

Connect.      Tel.
SUB 808076
to: 01191      ↓
ABORT  TM

```

- **User-User Information**

```

Connect.      Tel.
UUS: HELLO
                ↓
ABORT  TM

```

- **Display Information**

- **Type of number (T.o.n.)**

- **Numbering Plan (NP)**

- **Advice of charge**

The up-to-date AOC information will be presented on the third line of the display as it is received. With the < ↓ > you can scroll through additional information (if there is any).

```

Connect.      Tel.
Advice of charge
Units: 24      ↓
ABORT

```

Operation	
< ABORT >	Disconnect Return to the <i>Single tests</i> menu
< TM >	Call the Test Manager (see "Menu: Test Manager" on page 110)
↓-Key	There are other displays

If the charges are not given in units (the standard in

Germany), but rather directly as currency (e.g., in Switzerland and in Austria), the ARGUS will show the current amount in the currency.

If, in DSS1, the call charges are not provided in accordance with the ETS 300 182 standard, rather in the form of the information element DISPLAY (DSP), the DISPLAY message's character string will be displayed.

■ Procedure for an Incoming Call (ISDN)

An incoming call can be taken at any time even when a test (e.g. BERT) is in process (see “Starting Several Tests” on page 111).

The ARGUS will signal an incoming call with an audible tone and a message on the display.

In.call	Tel.
02351907070	B01
to: 90700	↓
REJECT	ACCEPT

<ACCEPT>

or



-Key

<REJECT>

↓-Key

Operation

Accept the incoming call

Reject the incoming call

Additional information is available (optional: indicated by the ↓ on the display) and can be displayed (e.g., SUB, UUS)

In the example above, the call has been placed from the call number 02351/907070. It is a telephone call. The connection was made using B-channel 1:

The 16-digit call number (DDI) will be displayed in its entirety, as long as the “Alerting mode” in the “Parameter” menu has been set to “manual” (see section 6.9.2.3 Alerting mode page 129).

On a P-MP access, you can use the *Call acceptance* (see

“Call Acceptance” on page 139) function to configure the ARGUS to only signal incoming calls which are addressed to the MSN that corresponds to your own call number. This function can only be used when your own call number has been entered into the ARGUS’s speed-dialing memory (see “Saving Call Numbers” on page 165) and the incoming call has a destination MSN.

After a call is taken, the following display will appear:

Connect.	Tel.
02351907070	B01
to: 90700	↓
ABORT	TM

Operation	
< ABORT >	Disconnect Return to the <i>Single tests</i> menu
< TM >	Call the Test Manager (see “Menu: Test Manager” on page 110)

A telephone connection to the subscriber with the call number 02351907070 now exists on B-channel 1.
Your own number is 90700.



If an external handset has been connected (see “Handset” on page 159), the following will be displayed when the call is accepted:

Connect.	Tel.
02351907070	B01
to: 90700	↓
ABORT	TM

Operation	
<Handset>	Switches to the internal handset (necessary in order to take a call, if no headset is connected.)
< ABORT >	Disconnect Return to the <i>Single tests</i> menu
< TM >	Call the Test Manager (see “Menu: Test Manager” on page 110)

Generating Advice of Charge information in NT mode:

If the ARGUS is in NT mode, the ARGUS will – for incoming calls – send advice of charges in accordance with DSS1 as units and as currency (in Euro)

6.6.2 Clearing down an ISDN connection

To clear (disconnect) the connection: Press <ABORT> or



-Key

When the ARGUS is clearing the connection or when it has been disconnected, it will display the following:

```
Call clearing
Normal clearing
Loc: User
CONT.
```

```
Call clearing
Normal clearing
Loc.: User
CONT.
```

< CONT. >

Operation

Return to the *Single tests* menu

The second line in the display will show the cause (see the table below) of the disconnect.

In the third line, the ARGUS shows the location of the party that initiated the disconnection or where the fault (causing the disconnect) occurred.

If the charges are sent at the end of the connection, the charges will be displayed accordingly.

The connection has now been cleared-down and the B-channel is released.

The following causes are shown in clear text:

Cause	Display	Explanation
255	Active clearing	<i>User actively initiated the disconnection</i>
Long 0	Normal clearing	<i>Cause element with Long 0 is mostly used by 1TR6</i>
01	Unalloc. number	<i>"No access under this call number" is signaled</i>
16	Norm. clearing	<i>Normal disconnect</i>
17	User busy	<i>The number called is busy</i>
18	No user respond	<i>No answer from the number called</i>
19	Call.time XX	<i>Call time too long</i>
21	Call reject	<i>The call is actively rejected</i>
28	Wrong number	<i>Wrong call number format or call number is incomplete</i>
31	Norm. clearing	<i>Unspecified "normal class" (Dummy)</i>
34	No B-chan.avail.	<i>No circuit / B-channel available</i>
44	Req.chan.unavail	<i>Requested B-channel not available</i>
50	Req.fac.not subs	<i>Requested supplementary service (facility) not subscribed</i>
57	BC not authoriz.	<i>Requested bearer capability is not enabled</i>
63	Srv./opt.n.avail	<i>Unspecified for "Service not available" or "Optional service not available"</i>
69	Req.fac.not impl.	<i>Requested facility is not supported</i>
88	Incompat. Dest.	<i>Incompatible destination</i>
102	Timer expired	<i>Error handling routine started due to time-out</i>
111	Protocol error	<i>Unspecified for "protocol error class"</i>
127	Interworking err	<i>Unspecified for "interworking class"</i>

Other causes are not shown in clear text, rather as decimal codes (see Appendix B and C).

6.6.2.1 Operation on an analog (a/b) access

■ Procedure for an Outgoing Call (analog)

The ARGUS sets up a connection to another terminal.

If the remote terminal is a telephone, you can use the integrated handset or an optional external headset to hold a conversation with the remote party.

The charges due will be displayed, if the information is available for the access under test.

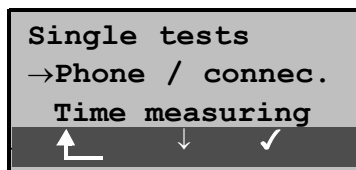

	Operation
< ↓ >	Select <i>Phone / connec.</i>
< ✓ >	Confirm the selection and the <i>Enter numbers</i> window will open
↶	Return to Main menu

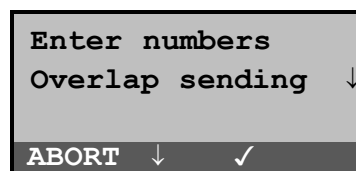

	Operation
< ↓ >	Select overlap or en-bloc signaling
< ✓ >	Confirm your selection and continue to the next display
< ABORT >	Return to the <i>Single tests</i> menu

Only with en-bloc signaling:

```

Enter numbers
Destination no.1
02351907070
ABORT  DEL  ✓

```

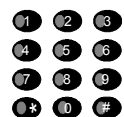

< DEL >

< ✓ >

↓ -Key

or

↑ -Key

<ABORT >

Operation

Enter the number digit-by-digit. The last number dialed will always be used as the default (simplified last number redial)

Delete the number digit-by-digit

Confirm the number and continue to the next display

Scroll through the stored numbers

Return to the *Single tests* menu

In “**overlap signaling**”, the call is started immediately, the dial tone is audible and the ARGUS is displaying its dialing window. In contrast to en-bloc signaling, you can now enter the call number digit-by-digit using the numeric keypad.

```

Telephony analog
to: 02351907070
AOC: 45
ABORT  ⏏

```

< ABORT >

< ⏏ >

Operation

Disconnect
Return to the *Single tests* menu

Generate a Flash signal

As soon as the remote party answers, a voice connection will be set up.

The charges will be displayed in the third line, if the access supports this feature.

■ Procedure for an Incoming Call (analog)

The ARGUS signals an incoming call both audibly and on the display.

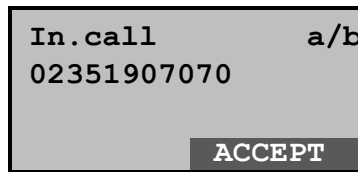

< ACCEPT >

or

-Key

Operation

Accept the incoming call

If the access supports CLIP, the ARGUS will display the number of the caller on the second line.

After accepting the call:

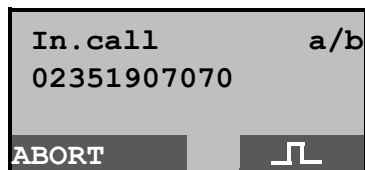

<ABORT>

<  >

Operation

Disconnect
and return to the *Single tests* menu

Generate a FLASH signal

6.6.3 Time measuring

The ARGUS can measure three different times: connection setup time, the propagation delay of the data and the difference between the propagation delays for the data on two B-channels. Time measurements on a BRI, PRI or U interface access are only possible in TE mode.

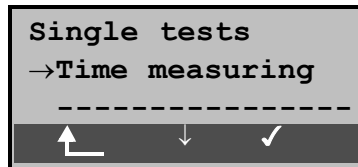

< ↓ >

< ✓ >

Operation

Return to the status display

Select *Time measuring*

Open the *Time measuring* function

6.6.3.1 Connection setup time

The ARGUS places an outgoing call and measures the time between sending the SETUP and receiving the ALERT or CONN.

After the *Connection setup time* function is started, you must enter the call number, the service and the B-channel (see "Setting up an ISDN connection" on page 63). The ARGUS disconnects automatically as soon as the measurement is completed.

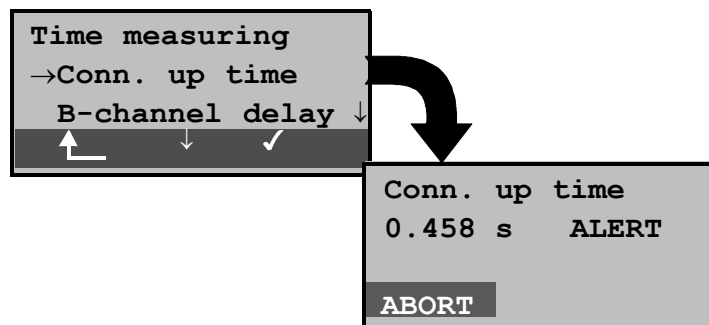

	Operation
↶	Return to the <i>Single tests</i> menu
< ↓ >	Select <i>Conn.up time</i>
< ✓ >	Open the <i>Conn.up time</i> function
In the second line of the display, the ARGUS will show the measured time in seconds (millisecond exact) and the received L3 message, which terminated the measurement time.	
< ABORT >	Quits the <i>Conn.up time function</i> , the ARGUS returns to the <i>Time measuring</i> menu

If the ARGUS cannot perform the measurement, e.g. because the call number entered was wrong or no B-channel was free, the corresponding cause will be displayed.

6.6.3.2 B-channel delay

The ARGUS places a call to itself (self call) or to a remote loopbox and measures the propagation delay for the data in the selected B-channel. The propagation delay is given in multiples of the time required for sending one byte at 64 kBit/s. (The time for sending 1 byte at 64 kBit/s = approx. 125 μ s.)

After the *B-channel delay* function is started, you must enter the call number, the service and the B-channel (see “Setting up an ISDN connection” on page 63). The ARGUS disconnects automatically as soon as the measurement is completed.

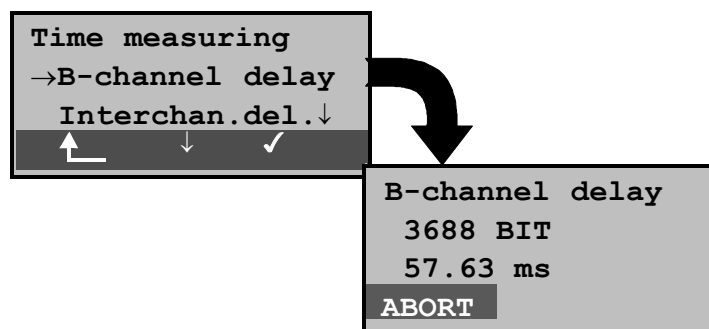

Operation	
↑	Return to the <i>Single tests</i> menu
< ↓ >	Select <i>B-channel delay</i>
< ✓ >	Open the <i>B-channel delay</i> function
The ARGUS displays the delay in bits (on the second line) and in milliseconds (on the third line).	
< ABORT >	Quits the <i>B-channel delay function</i> , the ARGUS returns to the <i>Time measuring</i> menu

If the ARGUS cannot perform the measurement, e.g. because the call number entered was wrong or no B-channel was free, the corresponding cause will be displayed.

When it is connected to a loopbox, if the ARGUS does not receive the data back within 13 seconds, it will display the message “No LOOP”.

6.6.3.3 Interchannel delay

The ARGUS establishes two separate connections to a remote loopbox. The loopbox sends the respective B-channel data back on the same channel. The ARGUS measures the propagation delay for the data on each of the B-channels and determines the difference between the two propagation delays (interchannel delay).

The difference in the propagation delay (interchannel delay) is given in multiples of the time required for sending one byte at 64 kBit/s.

(The time for sending 1 byte at 64 kBit/s = approx. 125 µs.)

After the *Interchannel delay* function is started, you must enter the call number, the service and the B-channel (see "Setting up an ISDN connection" on page 63).

The ARGUS disconnects automatically as soon as the measurement is completed.

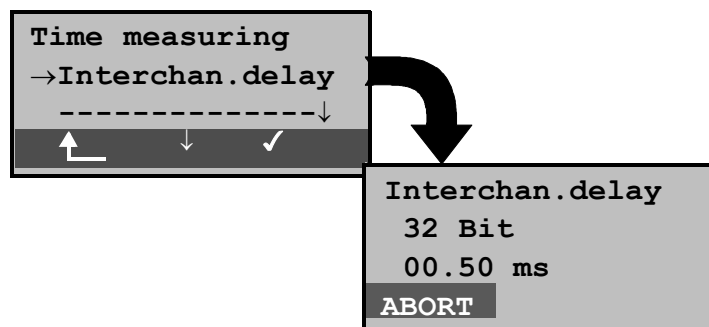

Operation	
↑	Return to the <i>Single tests</i> menu
< ↓ >	Select <i>Interchan.delay</i>
< ✓ >	Open the <i>Interchan.delay</i> function
The ARGUS shows the difference in the propagation delays in bits and in milliseconds.	
< ABORT >	Quit the <i>Interchan.delay</i> function The ARGUS returns to the <i>Time measuring</i> menu.

If the ARGUS cannot perform the measurement, e.g. because the call number entered was wrong or no B-channel was free, the corresponding cause will be displayed.

6 Menu

When it is connected to a loopbox, if the ARGUS does not receive the data back within 13 seconds, it will display the message "No LOOP".

6.6.4 Suppl.serv.tests DSS1

The ARGUS checks, which supplementary services are supported by the access being tested.

6.6.4.1 Suppl. Services Test with 1TR6

(only BRI or U interface)

Description

The ARGUS checks, which of the services listed below are supported by the exchange for the BRI or U-interface access (running the 1TR6 protocol) that is being tested:

Sperre	Blocking enabled for outgoing calls
AWS1	Call forwarding type 1 enabled (continuously)
AWS2	Call forwarding type 2 enabled (case by case)
Anschluss GBG	Access belongs to a Closed Users Group
Geb.anzeige	Display of charges is setup
Rufnummern-Id	Setup call number identification - against malicious calls

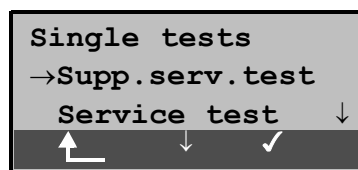

< ↓ >

< ✓ >

Operation

Return to the status display

Select the *Supplementary service test*

Open the *Supplementary service test* menu

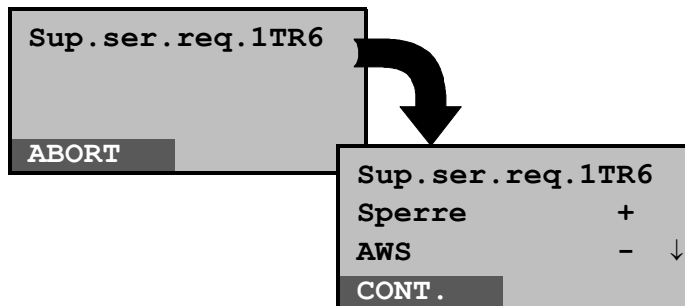

	Operation
<ABORT >	Abort the test Return to the <i>Single tests</i> menu
	As soon as the supplemental services interrogation is finished, the ARGUS will display the results in the second and third lines of the display:
↓ -Key	Scroll through the test results + means that the suppl.service is enabled - means that the suppl.service is not enabled
< CONT. >	Return to the <i>Single tests</i> menu

6.6.4.2 Suppl.service interrogation in DSS1

Currently, the ARGUS can individually test the following DSS1 supplementary services:

On a BRI access:

TP	Terminal Portability	Moving the terminal on the bus
HOLD	Hold	Hold/Broker
CLIP	Calling Line Identification Presentation	Display the caller's number
CLIR	Calling Line Identification Restriction	Suppress the caller's number
COLP	Connected Line Identification Presentation	Display the call number of the called subscriber with whom one is connected
COLR	Connected Line Identification Restriction	Suppress the number of the subscriber with whom one is connected
DDI	Direct dialling in	Direct dialling in to an extension on a PBX
CFU	Call Forwarding Unconditional	Forward all calls
CFB	Call Forwarding Busy	Forward calls when busy
CFNR	Call Forwarding No Reply	Forward calls when no answer
CW	Call Waiting	Call waiting
CCBS	Completion of Calls to Busy Subscriber	Automatic callback if party called is busy
CCBS-T	Completion of Calls to Busy Subscriber	Automatic callback if party called is busy (on P-P)
CCNR	Call Complete No Response	Automatic recall, if called party does not answer
CCNR-T	Call Complete No Response	Automatic recall, if called party does not answer (on P-P)
MCID	Malicious Call Identification	Identification of malicious callers (call tracing)
3pty	Three party	Three party conference
ECT	Explicit Call Transfer	Call transfer or directed call forwarding

AOC	Advice of Charge	Advice of charges
SUB	Sub-addressing	Sub-addressing is possible
UUS	User-to-User Signalling	Transfer of user data

On a PRI access:

On a PRI access, the following supplementary services will be tested:

TP, HOLD, CLIP, CLIR, COLP, COLR, CFU, CFB, CFNR, CFNR-T, CW, CCBS, CCBS-T, MCID, AOC, SUB, UUS

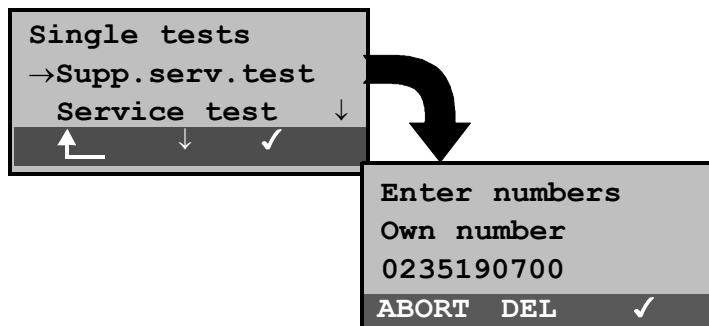

<p>↶</p> <p>< ✓ ></p> <p>< ↓ ></p> <p>⓪1 ⓪2 ⓪3 ⓪4 ⓪5 ⓪6 ⓪7 ⓪8 ⓪9 ⓪* ⓪0 #</p> <p>< DEL ></p> <p>< ✓ ></p> <p>< ABORT ></p>	<p>Operation</p> <p>Return to the <i>Main menu</i></p> <p>Select the <i>Supplementary service test</i></p> <p>Confirm your selection The window, <i>Enter numbers</i>, will now open.</p> <p>Enter your Own number; the suppl.services test is performed in part with a self call.</p> <p>Delete individual digits</p> <p>Confirm</p> <p>Abort the test</p>
---	---

Select service:

Select the service, which should be used for the entire suppl. services test

**Operation**

- ↓ -Key Select the *Service*
- < ✓ > Confirm the *Service* and the *B-channel select* entry dialog will open
- <ABORT > Abort the test

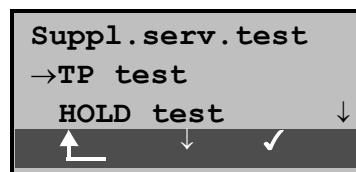
Select Test:**Operation**

- < ↓ > Select a test (e.g. *TP test*)
- < ✓ > Start the test
- ↑ Return to the *Single tests* menu

■ TP Test

The ARGUS tests the TP (Terminal Portability) supplementary service by making a self call.

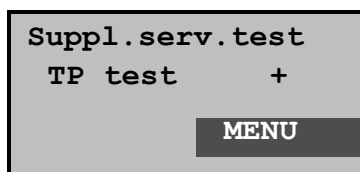

Operation

The test results are displayed in the second line:

+ = TP possible on this access

- = TP not possible on this access

Return to the *Suppl.serv.test* menu, where you can select the next type of test

< MENU >

■ HOLD Test

For this test, the ARGUS will make a self call.

Result: + = HOLD is possible on this access
 - = HOLD is not possible on this access

■ CLIP Test (CLIP / CLIR / COLP / COLR)

For this test, the ARGUS will make up to three self calls one after the other. In this test, the ARGUS checks whether the 4 supplementary services CLIP, CLIR, COLP and COLR are supported on the access under test.

The test will be performed automatically for all four supplementary services.

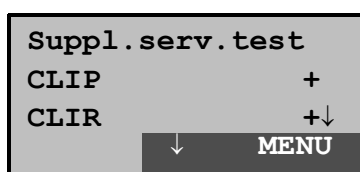

Operation

< ↓ >

Scroll through the test results

< MENU >

Return to the *Suppl.serv.test* menu

Test results:**CLIP**

Will the calling subscriber's number be displayed at the called subscriber?

- = no += yes

CLIR

Will the display of calling subscriber's number at the called subscriber be suppressed or is it possible to temporarily suppress the display?

- = no += yes * = no statement,
since CLIP is not setup

COLP

Will the call number of the subscriber who answered be displayed on the caller's phone?

- = no += yes

COLR

Will the display of the call number of the subscriber who answered be suppressed on the caller's phone or is it possible to temporarily suppress the display?

- = no += yes * = no statement,
since COLP is not setup



The suppl. services CLIP and CLIR as well as COLP and COLR

will be tested in pairs. If CLIR or COLR is setup permanently, it is **not** possible to make a clear assessment.

■ DDI Test

Test results:

Can a caller directly dial in to an extension on the PBX access under test?

- = no += yes

■ CF Test (CFU / CFB / CFNR)

This test checks whether the 3 supplementary services CFU, CFB and CFNR are supported on the access under test. The test is automatically performed for all three supplementary services.



The CF test attempts to setup a call diversion to the call number that is in the speed dialing memory location for “destination no. 1”. The CF test cannot be performed, if this location does not contain a valid call number to which it is possible to divert a call.

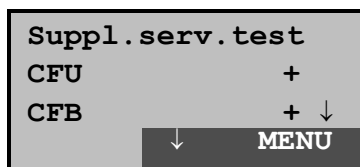

Operation

- < ↓ > Scroll through the test results
- < MENU > Return to the *Suppl.serv.test* menu

Test results:

CFU

Can this access immediately forward an incoming call?

- = no += yes

CFB

Can this access forward an incoming call when it is busy; in other words does it support Call Forwarding Busy?

- = no += yes

CFNR

Can this access forward an incoming call when it is not answered?

- = no += yes

■ CW Test

Test results:

Does the access under test support call waiting?

- = no += yes

■ CCBS or CCBS-T Test on a P-P Access**Test results:**

Will the access under test automatically recall a remote subscriber, if the number called was busy?

- = no += yes

■ CCNR or CCNR-T Test on a P-P Access**Test results:**

Will the access under test automatically recall a remote subscriber if the call was not answered?

- = no += yes

■ MCID Test**Test results:**

Does the access tested allow identification of malicious callers (call tracing)?

- = no += yes

■ 3pty Test**Test results:**

Does the access under test support a three-party conference call?

For this test, you need the assistance of a remote subscriber, whose call number must be entered.

- = no += yes

■ ECT Test**Test results:**

Is an explicit call transfer supported by the access under test?

For this test, you need the assistance of a remote subscriber, whose call number must be entered.

- = no += yes

■ AOC Test

The ARGUS checks whether the charges can be sent to the access under test. The test uses a call to oneself to check both AOC-D (AOC during a call) and AOC-E (AOC at the end of a call).

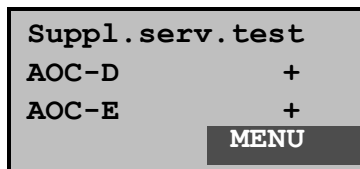

< MENU >

Operation

Return to the *Suppl.serv.test* menu

■ SUB Test

A call is made to oneself and answered to check the transfer of the sub-address in both directions.

Test results:

Are sub-addresses supported on the access under test?

- = no += yes

■ UUS Test

Test results:

Does the access under test support the transfer of user data?

- = no += yes

6.6.4.3 Suppl. Services Tests – Error messages

If an error occurs during a `suppl.serv.test` or if it is not possible to setup a connection, the ARGUS will display the corresponding error code (second line in display) plus the error class in clear text (third line in the display).

```
Suppl.serv.test
Error:          28
Wrong subsr.no.
```

In the example, an error with the code 28 has occurred. The error belongs to the error class "wrong or invalid number".

In the table below, you will find that this is an error from the network and that it reports that the call number was incomplete or in the wrong call number format (see "CAUSE-Messages – DSS1 Protocol" on page 186).

Distributing the error codes into error classes:

Error class	Description	Cause network)		
		1 TR6	(from DSS1	Cause ARGUS internal
A	No or another access	—	—	201,204,205, 210,220
B	Wrong or invalid number	53, 56	1,2,3,18,21 22,28,88	152,161,162, 199
C	One or more B-channels busy	10,33,59	17,34,47	—
D	Wrong service	3	49,57,58,63 65,70,79	—

For further information regarding error codes: "ARGUS Error Messages" on page 190, "CAUSE-Messages – DSS1 Protocol" on page 186 and "CAUSE-Messages – 1TR6 Protocol" on page 188.

6.6.5 Service check

The ARGUS checks, which of the following services are supported by the access under test:

- Tel. analog
- Tel. ISDN (3.1 kHz)
- Tel. 7kHz
- Speech
- 7kHz Audio
- Videotext
- Fax G3
- Fax G4
- UDI 64kBit/s
- Teletext
- Video conference 1
- Video conference 2

The test runs automatically.

For each service, the ARGUS will place a call to itself (to the access under test). However, the call will not be answered so no charges will be incurred.

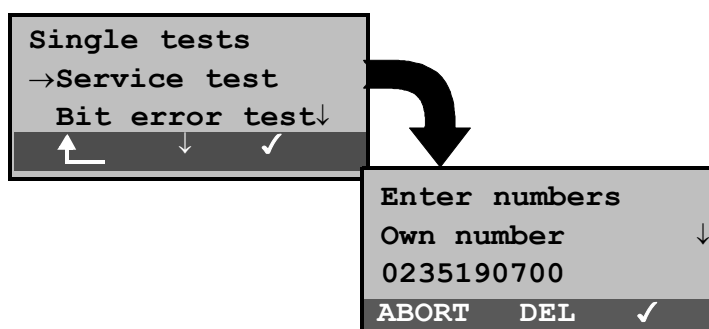

<p>↶</p> <p>< ✓ ></p> <p>< ↓ ></p> <p>1 2 3 4 5 6 7 8 9 * 0 #</p> <p>< DEL ></p> <p>< ✓ ></p> <p><ABORT ></p>	<p>Operation</p> <p>Return to the <i>Main menu</i></p> <p>Select <i>Service check</i></p> <p>Confirm your selection</p> <p>The window, <i>Enter numbers</i>, will now open:</p> <p>Enter your Own number, the <i>Service check</i> is performed using a self call.</p> <p>Delete individual digits</p> <p>Confirm</p> <p>Return to the <i>Single tests</i> menu</p>
---	---



There are PBXs that use separate call numbers for incoming and outgoing calls.

In this case, for the Service checks, you can enter a “**remote**” call number that corresponds to the “own” number that is not stored in the ARGUS.

If the Service check should extend outside of the local exchange, it is possible to perform the Service check in an **end-to-end mode**.

In this case, you **must** enter the remote call number for a second terminal device.

The ARGUS will then automatically check whether the remote terminal can accept the call under the various services – in other words, whether it is “compatible” with these services.

In the test results, the second part (second +, - or *) refers to the answer from the **remote** exchange.

Once the test is completed, the ARGUS will display the results:

```

Service test
Tel.analog   + +
Tel.ISDN     + +
              ↓
              MENU
  
```

< ↓ >

Operation

Scroll through the test results

< MENU >

Return to the *Single tests* menu

Interpreting the test results:

The ARGUS makes a distinction between outgoing calls (the first +, - or *) and incoming calls (the second +, - or *).

- + Service supported
- Service not supported
- * Result not definite

The reason that it is not possible to make a definite statement is given in the adjacent error code.

Displayed	Description
-----------	-------------

- | | |
|----|---|
| ++ | The self call functions OK or the remote end can take the call for this service |
|----|---|

- + - Call was sent successfully, however, it was rejected on the remote end due to missing authorization. (Error class D in a B-channel message e.g. in a SETUP_ACK or CALL_SENT)
- An outgoing call with this service is not possible (Error class D without a B-channel message)
- + * Call was sent successfully, the call back or call to the remote end failed (e.g., remote end busy or no B-channel available for the call back). (Error class B, C or E in a B-channel message)
- * Wrong number, no B-channel available or other error (Error class B, C or E without a B-channel message)

If the outgoing call is not successful, it is **not** possible to make a statement about an incoming call. Therefore, you will never see “- +” or “- *” on the display.

Example:

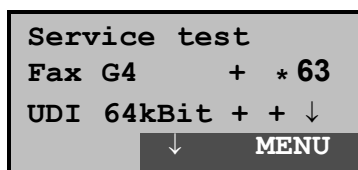

```
Service test
Fax G4      + * 63
UDI 64kBit + + ↓
           ↓ MENU
```

- For outgoing, the Fax G4 service is OK. No statement is possible about incoming.

The error code 63 gives the coded cause of the error (see the table in the Appendix).

In this case, it is recommended that you have someone place a call to the access under test using this service.

- The UDI 64kBit service is possible in both directions.

If an error of error class A occurs (see “Suppl. Services Tests – Error messages” on page 91) the Service test will be aborted.

An error of any other error class will be coded in decimal (in the example above 63), assigned to the respective service and then displayed.

6.6.6 Bit error test

The bit error rate test (BERT = Bit Error Rate Test) serves to check the transmission quality of the access circuit.

As a rule, the network operator will guarantee an average error rate of 1×10^{-7} , in other words in long-term operation 1 bit error in 10 million transmitted bits. A higher bit error rate will be especially noticeable in transmitting data.

The application program detects the errors in the data blocks transmitted and requests that the remote partner send them again, which reduces the effective throughput of the ISDN connection.

In the bit error test, the tester establishes an ISDN connection to a remote tester or places a call to itself, sends a standardized (quasi-) random number string and compares the received data with that which was sent. The individual bit errors are summed and depending on the test procedure and equipment evaluated in accordance with the ITU Guidelines G.821 and G.826.

During the test, the ARGUS counts the bit errors and after the test is done it calculates the bit error rate and other parameters in accordance with G.821.

Since the bit error test checks both B-channels in both directions at the same time, both B-channels are required.

The duration of the BERT can be set in the *Configuration/BERT* (see "BERT - duration" on page 141) menu (default setting = 1 minute).

As a rule, the quality of the network operator's access circuits is quite good. Therefore, no bit errors should occur in a 1-minute test.

However, if an error occurs, the test should be repeated with a measurement time of 15 minutes to achieve higher statistical precision. If more than 10 bit errors occur during this 15-minute test (call to oneself), the access circuit is too heavily distorted.

Contact the network operator or the supplier of the PBX equipment and ask them to test your access circuit.

The BERT can be performed in three different ways:

1. BERT in an extended call to oneself

A remote number is not needed, since the ISDN connection is setup to oneself. In this case, the ARGUS requires two B-channels for the test.

2. BERT with a loopbox

A loopbox (e.g., another member of the ARGUS family of testers at the remote end) is required.

The test uses one B-channel.

3. BERT end-to-end

This test requires a waiting remote tester such as an ARGUS in the *BERT wait mode* (see section 6.6.6.2 page 102). A bit pattern is sent to this tester.

Independent of the received bit pattern, the remote tester uses the same algorithm to generate the bit-pattern that it sends back.

Therefore, both directions are tested independently.

6.6.6.1 BERT start

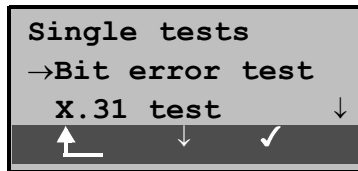
**Operation**

Return to the status display

Select the *Bit error test*

Open the *Bit error test* menu

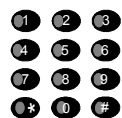
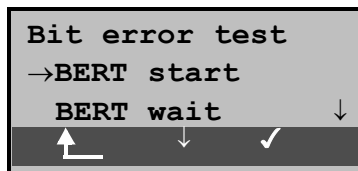
**Operation**

Return to the *Single tests* menu

Select *BERT start*

Confirm your selection

The window, *Enter numbers*, will now open.

Enter your **Own number** to perform the BERT in an extended call to oneself (2 B-channels).

or

a **remote number** for a BERT to a loopbox (1 B-channel) or end-to-end

Confirm call number

The *Select service* window will now open.

Select the service under which the connection should be setup

Confirm the selection

and the *B-channel select* dialog will open.

Select B-channel for connection (enter an * to select any free B-channel)

Start the bit error test

<ABORT > Return to the *Single tests* menu

After the ARGUS has setup the connection and synchronized the send and receive directions, it will display the B-channel used (line 1: here B02), the remaining test time in hours:minutes:seconds, the number of bit errors that have occurred (line 2) and the synchronicity of the bit pattern (line 3 - synchronous or asynchronous).

BERT	B02
15:45:42	3
Synchronous	
ABORT	TM ERROR

Operation

< Error > Injects an “artificially generated” bit error, which can demonstrate the reliability of the measurements when running end-to-end tests

< TM > Call the Test Manager (see “Menu: Test Manager” on page 110)

<ABORT > Abort the bit error test



When a bit error is detected, this will be signaled by a brief alarm; in the event that the synchronization is lost, a constant alarm will sound.

The measurement time for the BERT can be specified with the *Configuration* function (see section 6.9.3.1 BERT - duration page 141).

After the test is done, the ARGUS will display the cause on the second line and the location which initiated the disconnect will be shown on the third line.

If the test ran normally, the ARGUS will display “Active clearing” on this line. *.*

```

Call clearing
Active clearing
Loc.: user ↓
CONT.

```

< CONT. >

Operation

Display the test results

```

BERT          B02
Result:10309kB
10           9.7E-07 OK
MENU        TM        MORE

```

< MORE >

Operation

Display additional test results

< MENU >

Return to the Bit error test menu

< TM >

Call the Test Manager (see "Menu: Test Manager" on page 110)

Display results:

First line: B-channel used (in the example B-channel 2)

Second line: Transferred data in kBits (in the example 10309 kBits)

Third line: Number of the bit errors that have occurred (in the example 10)
Bit error rate (in the example $9.7 \cdot 10^{-7}$ (= 0.00000097))

The evaluation of the results depends on the error threshold that you set (see "BERT - Setting the Error Level" on page 143).

OK = bit error rate is less than the error threshold (set by the user) and NO = bit error rate is above the error threshold.

Furthermore, it is possible to display more characteristic values (<MORE> softkey), the ARGUS determines the following in accordance with the ITU-T G.821 and G.826:

- HRX** (G821 and G826)
Defines the hypothetical reference connection
The HRX for G.826 cannot be set separately, it corresponds to the HRX for G.821.
- EFS** ***Error Free Seconds*** (G.821)
All the seconds in which no error occurred.
- ES821** ***Errored Seconds*** (G.821)
All the seconds in which one or more errors occurred.
- SES821** ***Severely Errored Seconds*** (G.821)
All the seconds in which the bit error rate is $>10^{-3}$.
In one second, 64,000 bits are transferred, thus **BitError** $=10^{-3}$ equates to 64 bit errors.
- US** ***Unavailable Seconds*** (G.821)
All the sequentially adjacent seconds (at least 9 sec) in which **BER** $>10^{-3}$.
- AS** ***Available Seconds*** (G.821)
All the sequentially adjacent seconds (at least 9 sec) in which **BER** $<10^{-3}$.
- DM** ***Degraded Minutes*** (G.821)
All the minutes in which the bit error rate is $>10^{-6}$. In one minute, 3,840,000 bits are transferred, thus a **BER** $= 10^{-6}$ corresponds to 3.84 bit errors (3 errors = NO (no DMs), 4 errors = OK (DM)).
- LOS** ***Loss of Synchronization***
Synchronization is lost at an error rate $>$ or $= 20\%$ within a second. The absolute number of synchronization losses will be shown.
- EB** ***Errored Block*** (G.826)
Block with one or more errors
- ES826** ***Errored Second Rate*** (G.826)
Seconds with at least one block error
- SES826** ***Severely Errored Second Rate*** (G.826)
Seconds with many errors, i.e. more than 30% of the blocks have errors or at least one SDP (see below)
- BBE** ***Background Block Error Rate*** (G.826)
Background block error rate: The ratio of the

defective blocks to the total number of blocks in the measured period without counting the SES blocks

SDP *Severely disturbed Period* (G.826)
Severely disturbed period due to the occurrence of errors (LOS, LOF, AIS,.....) or an “out of service” BER $\geq 10^{-2}$.

All the values are displayed in % (percentages).

BERT	B02
HRX G821 :	15% OK
HRX G826	15% ↓
MENU	TM

	Operation
< MENU >	Return to the <i>Bit error test</i> menu
↓ -Key	Scroll through the test results
<SIMPLE>	Return to the display of the “Simple” evaluation
< TM >	Call the Test Manager (see “Menu: Test Manager” on page 110)

The ARGUS evaluates whether the test results satisfy the limits specified in the CCITT G.821 and G.826 under consideration of the defined hypothetical reference connection HRX (displaying OK or NO).

6.6.6.2 Bert wait

For this operation mode, it is necessary to use the *BERT start* function in an end-to-end test.

The ARGUS first waits for a call and then sets up the connection.

During the connection, the received bit pattern will be evaluated and an additional independent bit pattern will be sent.

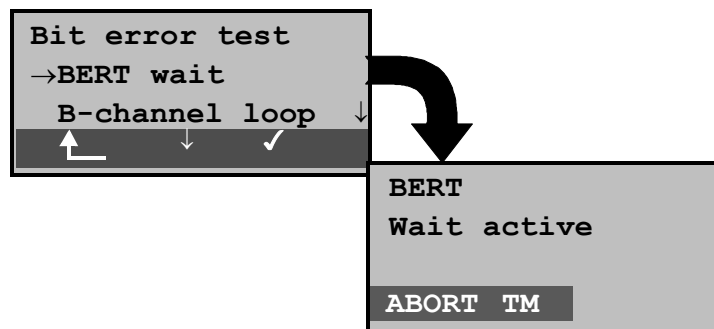

	Operation
< ↓ >	Select <i>BERT wait</i>
< ✓ >	Start the <i>BERT wait</i> function The ARGUS is in the active <i>BERT wait</i> mode.
↶	Return to the <i>Bit error test</i> menu
< TM >	Call the Test Manager (see "Menu: Test Manager" on page 110)
< ABORT >	Stop the <i>BERT wait</i> function

The ARGUS displays that will appear are the same as those in *section 6.6.6.1 BERT start*.

The time shown is the current amount of time that *BERT wait* has run.

6.6.6.3 B-channel loop

When the B-channel loop function is active, the ARGUS will automatically take an incoming call for any service and switch a loop back in the B-channel that is specified by the exchange.

The received bit pattern will be sent back to the caller/sender.

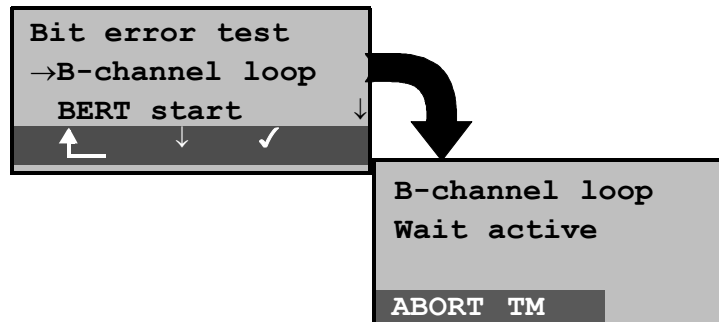

	Operation
↶	Return to the <i>Single tests</i> menu
< ↓ >	Select <i>B-channel loop</i>
< ✓ >	Start the <i>B-channel loop</i> function The ARGUS is waiting for a call. An incoming call will be taken immediately and switched in a loop to the appropriate B-channel. The ARGUS displays the call number and the B-channel used in the second line.
< TM >	Calls the Test Manager see "Menu: Test Manager" on page 110
< ABORT >	Quit the <i>B-channel loop</i> function

The "B-LOOP connect." window, which is similar to the normal connection window, will open:

```
B-LOOP connect.  
235190700      B01  
to: 907070      ↓  
ABORT
```

Operation	
↓ -Key	Display additional information (e.g. UUS...)
< TM >	Calls the Test Manager see "Menu: Test Manager" on page 110
< ABORT >	Disconnect B-channel loop

A second B-channel loop connection can be started via the Test Manager (see "Starting Several Tests" on page 111).

6.6.7 X.31 Test (only on a BRI access)

The X.31 test consists of two steps:

First step: The ARGUS tests whether it is possible to access the X.25 service via the D-channel on the access under test.

The ARGUS sequentially checks all the TEIs from 0 to 63. All the TEIs with which the X.31 service is possible on Layer 2, will be shown on the display.

Second step: For each TEI with which X.31 is possible on Layer 2, a CALL_REQ packet will be sent and then the ARGUS will wait for an answer.

Beforehand, the ARGUS will request the entry of the X.25 access number, which will be saved in speed-dialling memory under *X.31 test number* ("Saving Call Numbers" on page 165).

With the entry of the X.25 access number, you can - if you wish - select a logical channel (LCN) other than the default. For this purpose, append a "#" plus desired the LCN to the access number (default: LCN = 1).

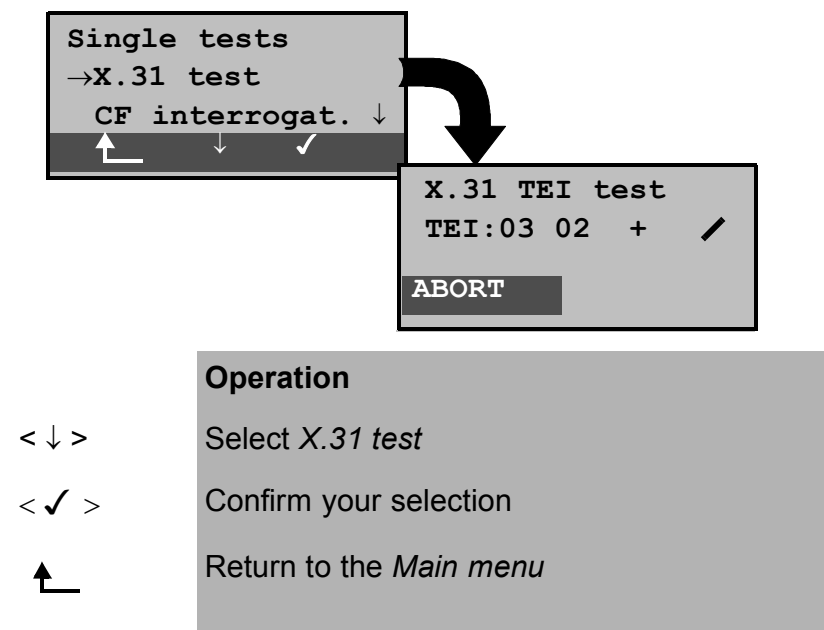

The test can take up to 4 minutes during which the ARGUS will display a rotating bar. In the second line, beginning at the left, you will find the just tested TEI and its result:

+ = X.31 is available for this TEI

- = X.31 is not available for this TEI

- <ABORT > Stop the test and return to the *Single tests* menu
- < NEW > Repeat the X.31 test

After the test sequence is completed, the ARGUS will show whether the X.31 service is available for Layer 3 for the TEIs found in Step 1.

```

X.31 TEI test
TEI:02 + +
TEI:03 + - 13 67
MENU      ↓      NEW
  
```

Operation

- < ↓ > Scroll through the test results
- < MENU > Return to the *Single tests* menu
- < NEW > Repeat the X.31 test

Test results:

TEI 02 = the first valid TEI value is 02.

+ + = Both test steps were successful

+ - = the first test step was successful, the second step not In this case, the ARGUS will display the relevant X.31 cause for the failure (in the example above: 13) and an associated diagnostic code (in the example: 67), if there is one.

If the X.31 service is not available, the ARGUS will show the message "x.31 (D)n. impl."

6.6.8 CF interrogation (only on a BRI access)

The ARGUS will check whether a call diversion is setup in the exchange for the access under test.

After the test, the ARGUS will show the type of diversion (CFU, CFNR or CFB) and the call diversion's service. The display is limited to a maximum of 10 call diversions for all of the MSNs.

Any call diversion setup in the exchange can be cleared with the ARGUS.

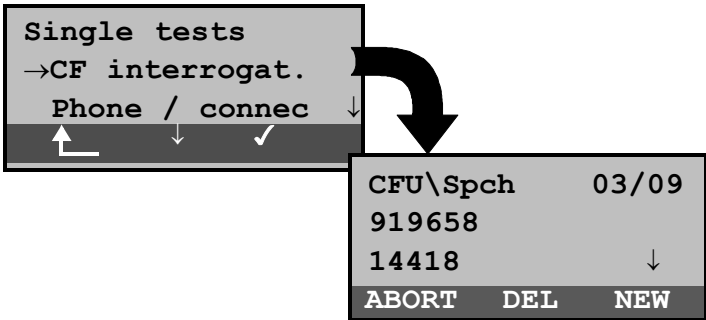

Operation	
< ↓ >	Select <i>CF interrogation</i>
< ✓ >	Confirm your selection
↶	Return to the <i>Main menu</i>
The test can take a few seconds, during which a bar will rotate on the display.	
↓ -Key	Scroll through the test results
< DEL >	Clear the displayed call diversion
< NEW >	Repeat the CF interrogation

Example test results:

First line: This is a CFU call diversion for the Speech service (Spch see the table page 109) It is the third call diversion shown of a total of 9 found.

Second line: Diversion to own number (in the example: 919658)

Third line: Destination number for the diversion (in the example: 14418)

Clearing a call diversion

After you press , a query will appear asking whether you are sure.

```
CFU\Spch    03/09
919658
Are you sure?
ABORT      DELETE
```

< DELETE >

Operation

The ARGUS clears the displayed call diversion in the exchange.

<ABORT >

Abort the process; the displayed call diversion will not be cleared

When the diversion is cleared correctly in the exchange, the following will be displayed:

```
CF deactivated !
CONT.
```

If the call diversion could not be cleared, the ARGUS will report:

```
CF
not changeable
CONT.
```



Some PBXs or exchanges do not permit the use of the mechanism used (by the ARGUS) for the CF test for all MSNs or they return a negative acknowledgment of the CF interrogation, implying that no CF was setup.

Therefore, in the event of a negative acknowledgment, the ARGUS will request that you enter your **own** MSN.

The CF interrogation will be repeated **MSN-specific**.

Naturally, in this case, the results of the CF test only apply for the entered MSN and **not** for the entire access.

Abbreviations used for the services and service groups on the display:

Basic Service	Abbreviation
All services	All
Voice (speech)	Spch
Unrestricted digital information	UDI
Audio 3.1 kHz	A3k1H
Audio 7 kHz	A7khz
Telephony 3.1 kHz	Tel31
Teletext	TTX
Fax Group 4	FaxG4
Video syntax based	ViSyB
Video Telephony	ViTel
Telefax Groups 2/3	FaxG3
Telephony 7 kHz	Tel7
Data Comm. 64kBit	DFU
Unknown Basic Service	Unkno

6.7 Menu: Test Manager

The ARGUS can simultaneously start several tests or “connections” fully independently of each other.

A maximum of 31 simultaneous “connections” are possible. As an example, a BERT can be run at the same time that you make a phone call. The individual tests or “connections” use resources.

All of the tests that have been started will be administered by the Test Manager. Using the Test Manager you can start new tests, switch between tests running in parallel or terminate all of the tests that are currently running.

Calling the Test Manager in the Main menu:

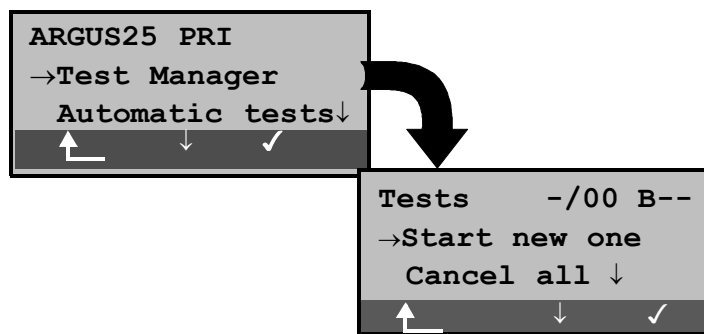

	Operation
< ↓ >	Select the <i>Test Manager</i> menu
< ✓ >	Confirm your selection
⏪	Return to the status display
< ↓ >	Select the desired menu item e.g. <i>Start new one</i> The ARGUS displays the number of the selected test, the number of tests started and the B-channel used by the marked test. (-/00 B--)
< ✓ >	Confirm
⏪	Return to Main menu



If the ARGUS is in the Connections or Single tests menu or one of their functions, the Test Manager can be opened using the **6-Key** or via the < TM >softkey.

6.7.1 Starting Several Tests

■ Starting a new test or connection during an existing connection

The ARGUS has an existing connection (see section 6.6.1.1 Setting up an ISDN connection page 63). Open the Test Manager (6-Key or < TM >).

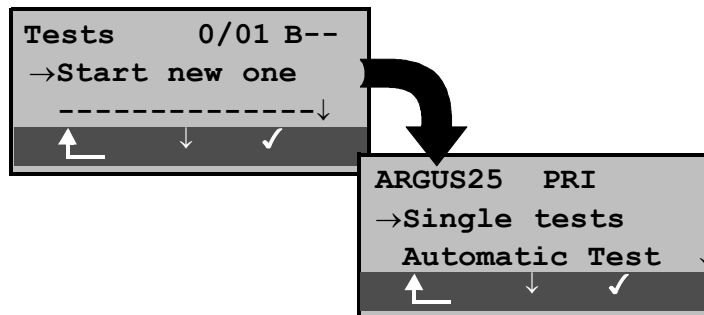

Operation	
< ↓ >	Select the <i>Start new one</i> function
< ✓ >	The ARGUS jumps to the status display
↶	Returns to the existing connection
The ARGUS jumps to the Main menu from which you can start other tests as usual.	

Start another test, e.g. the bit error test from the Single tests / Bit error test menu (see section 6.6.6.1 BERT start page 97). Similar to Chap. 6.6.5.1, the ARGUS will perform a bit error test independent of the currently existing connection.

BERT	B02
15:45:42	3
Synchronous	
ABORT	TM ERROR

Operation

< TM >

The ARGUS jumps to the Test Manager

<ABORT >

Cancels the bit error test and displays the BERT results. In the BERT results window, press the <TM> softkey to return to the Test Manager.

■ Cancelling the Test

If a test (or connection) is cancelled, the ARGUS will return to the Test Manager if there are any other tests (or connections) running in the background.

All of the existing connections (and/or tests) will be displayed by the Test Manager:

Tests	1/03	B02
→BERT		
BERT		↓
↑	↓	✓

Operation

< ↓ >

Scrolls through all of the existing connections or tests. The ARGUS displays the B-channel used for the just selected test (in the example a BERT) in the first line.

Example: The marked BERT is the first test started (1/...) of a total of three currently running tests (.../03 ...) and it uses B-channel 2 (..... B02)

< ✓ >

The ARGUS will jump to the marked test.



The ARGUS will return to the point from which the Test Manager was called (e.g. to a test running in parallel). If this is not reasonable, because e.g. no other test is running, the ARGUS will return to the Main menu.



Some tests use so many resources that they cannot be run in every combination with other tests. In this case, the ARGUS will display the message “Test not possible at this time”.

Test/ Connection	Number of times that this test/connection can be started at the same time	It is possible to change to another test
Incoming call	30	Yes
Outgoing call	30	Yes
BERT	2	Yes
LOOP	2	Yes
Service tests	1	No
Suppl.serv.test	1	No
Time measuring <i>Setting up call</i>	1	No
Time measurement <i>B-channel delay</i>	1	No
Time measurement <i>Interchannel delay</i>	1	No
X.31 test	1	No
CF interrogation	1	No

Auto. Test	1 When the Auto. Test is running all of the resources are in use and no other tests or connections are possible	No
S ₀ level	1	No
S ₀ level, remote end	1	No
U voltage	1	No
U power	1	No
a/b voltage	1	No

■ Accepting an incoming call/connection during a running test

The ARGUS signals an incoming call with a corresponding message on the display and an audible signal (see section 6.6.1.1 Setting up an ISDN connection page 63).

The incoming call can be accepted without influencing the currently running test. If the functions *B-channel loop* or *BERT wait* are active, the call will be accepted automatically.

The manner that multiple connections are handled is illustrated in the following example of an incoming call that arrives during a BERT, but it is identical for all other tests.

The ARGUS is performing a bit error test as an incoming call is signaled on the display:

In.call	Tel.
02351907070	B01
to: 90700	↓
REJECT	ACCEPT

	Operation
<REJECT>	Reject the incoming call. The ARGUS returns to the running test (in the example: to the BERT)
<ACCEPT>	Accept the incoming call. The ARGUS will then jump to the "Connections" dialog. The connection is active and in the foreground. The BERT continues to run in the background and can be viewed via the Test Manager (6-Key).
6 -Key	The ARGUS jumps to the Test Manager

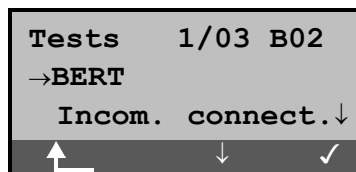

	Operation
<↓>	Select the <i>BERT</i>
<✓>	The ARGUS jumps to the BERT
↶	The ARGUS will then return to the "Connections" dialog.



If available, the internal handset will be assigned to the currently started (voice) connection. There is no support for switching the handset to another voice call. The assignment of the handset to a given connection is also retained in the background.

6.7.2 Switching Between Tests

First call the Test Manager.

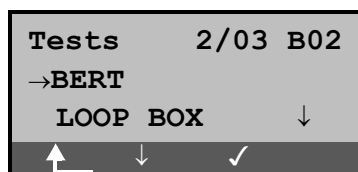

< ↓ >

Operation
Mark the test (connection) that you wish to switch to

< ✓ >

The ARGUS will jump to the selected test.

↑

The ARGUS will return to the point from which the Test Manager was called

6.7.3 Cancel all

First call the Test Manager.

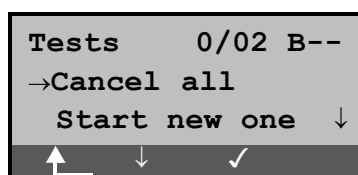

< ↓ >

Operation
Select *Cancel all*

< ✓ >

The ARGUS will cancel all of the currently running tests/connections and then return to the Main menu.

↑

The ARGUS will return to the point from which the Test Manager was called

6.8 Menu: Automatic Test

The ARGUS executes a test sequence automatically.

The test results will be shown in the display.

With the special optional cable (RJ45 to Centronics connector), you can print out a simple test report on a Centronics printer.

The test results can also be saved on a PC and then be viewed and printed as a comprehensive test report.

The ARGUS automatically performs the following sequence of tests:

On a BRI or U interface access (ARGUS in TE Mode)

- Level measuring
- Service tests
- BERT in an extended call to oneself
- Suppl.serv.test (tests the supplementary services)
- X.31 test
- CF interrogation

On a PRI access (ARGUS in TE Mode)

- Reset L1 counter
- Service tests
- BERT in an extended call to oneself
- Suppl.serv.test (tests the supplementary services)
- Read the L1 counter and measurement time

On an ISDN permanent circuit

- Level measuring
- BERT in end-to-end mode (e.g. with a loopbox on the remote end)

The test results and the time will be saved in the ARGUS together with the date (assuming the exchange sent it via the D-channel).

Additionally, settings such as your own plus a remote call number will also be saved.

The test results are stored in non-volatile memory and are not lost when the ARGUS is switched off.



The ARGUS can save the results of several test series (records 1,2,3...).

Each function in the *Automatic test* menu refers to one of the test series saved as a record.

Therefore, the first step will open a dialog in which you must select the desired data record.

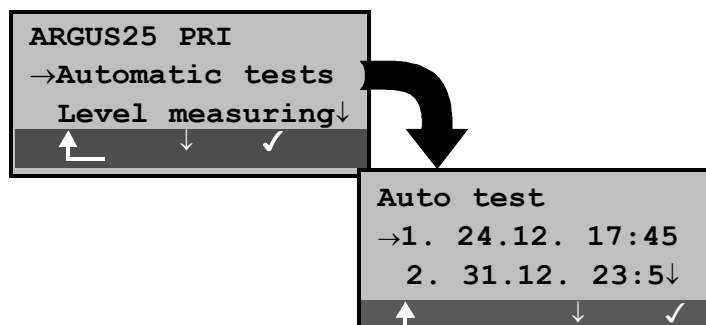

	Operation
< ↓ >	Select <i>Automatic Test</i> menu
< ✓ >	Confirm your selection
⌞	Return to the status display
< ↓ >	Select record: Each data record (holding the results of a saved test) is identified by a sequential number plus the date and time "Free" data records have only a number.
< ✓ >	Confirm A menu with various functions for processing the selected data record will open automatically.
⌞	Return to Main menu

If function key 4 is pressed at any place in the menu to start an automatic test, a data record will be selected automatically and the Automatic test will begin immediately. The result will be saved in the first data record that is free (e.g. No.3 when two test series are already saved).

When all five record numbers have been used, the ARGUS will jump to the "Autom.Test" menu and suggest that the oldest of the saved test results be overwritten.

6.8.1 Starting the Automatic Test

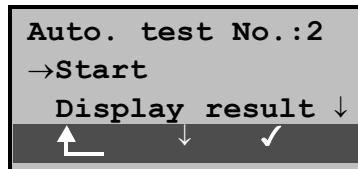

Operation	
< ↓ >	Select <i>Start</i>
< ✓ >	Confirm your selection
	Return to the <i>Autom. Test</i>
	Enter your Own number <i>Only on accesses with the DSS1 protocol:</i> also enter a remote call number
< ✓ >	Confirm
< ↓ >	Select service (will be used for the suppl.serv.test)
< ✓ >	Start test



Before running a BERT, check and, if necessary, modify the measurement time and error level (threshold) (see section 6.9.3.1 BERT - duration page 141).

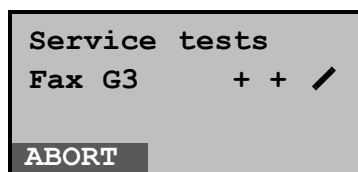

During the test series, the first three lines in the display will reflect the test currently being run. If the test series is canceled (= **ABORT**> softkey) the following menu will open:

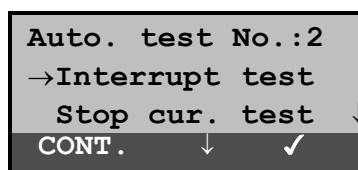

In this menu, you have the option of aborting the entire currently running series of tests or skipping individual test segments (e.g. service check).

■ Test - interrupting

An automatic test series can be terminated before it is finished:

```
Autom. Test No.2
→Interrupt test
  Stop cur. test ↓
CONT.           ↓ ✓
```

< ↓ >

< ✓ >

< CONT. >

Operation

Select *Interrupt test*

Confirm that the test should be stopped

Continue the test series



If the automatic test is interrupted, the test results gathered up to this point will **not** be saved.

Any “old” data stored under this data record number from a prior test will be retained.

■ Test point – skipping

Individual test points can be skipped in the following manner:

```
Auto. test No.:2
→Stop cur.test
  Continue test ↓
CONT.           ↓ ✓
```

< ↓ >

< ✓ >

< CONT. >

Operation

Select *Stop cur. test*

The test currently being performed will be skipped (e.g. BERT) and the next test in the sequence will start.

In this case, the interrupted test (e.g. BERT) will be repeated and the test series resumed.

■ Continue test

If you have interrupted a test series with <ABORT>, the interrupted series can be resumed. In this case, the interrupted test (e.g. BERT) will be repeated.

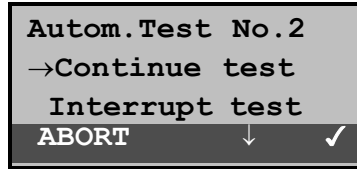

Operation

< ↓ >

Select *Continue test*

< ✓ >

In this case, the interrupted test (e.g. BERT) will be repeated and the test series resumed.

< CONT. >

The interrupted test will be repeated and the test sequence will continue.

6.8.2 Display result

The ARGUS displays the result of the automatic test.

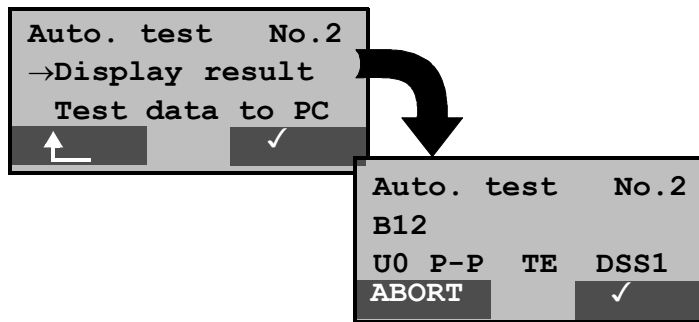

Operation	
< ↓ >	Select <i>Display result</i>
< ✓ >	Confirm your selection
↶	Return to the <i>Autom. Test</i> menu
<hr/>	
< ✓ >	Continue to the next results window
< ABORT >	Return to the <i>Autom. Test No.x</i>

The results of the individual tests will be displayed in the following order:

For: <i>BRI or U</i>	<i>PRI</i>	<i>ISDN perm. circuits.</i>
- Status	Status	Status
- Level measuring measuring	Service test	Level
- Service test	BERT	BERT
- BERT	Suppl.serv.test	
- Suppl.serv.test	L1 counter and time	
- X.31 test		
- CF interrogation		

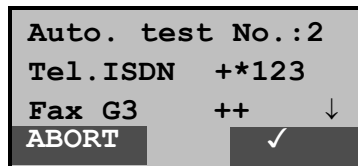

Operation	
< ↓ >	Scroll through the results of a test
↶	Jump to the results of the next single test
< Abort :>	Return to the <i>Autom. Test No.2</i>

The interpretation of the test results is described in the individual sections (e.g. in section 6.6.5 Service check page 92).

6.8.3 Test results – sending to a PC

To visualize and archive the test results on the PC, the data records can be transferred to the PC via the serial interface using the included cable (connect the cable between the ARGUS “L-Test” jack ---- PC’s serial interface) or wireless using the IrDa interface (see “PC Access” on page 164).

Connect the ARGUS to your PC.

■ Procedure on the PC

Start *ARGUS WINplus* on the PC.

First select the data record, which should be transferred to the PC (in the following example Test No.2) and then start the transfer of data:

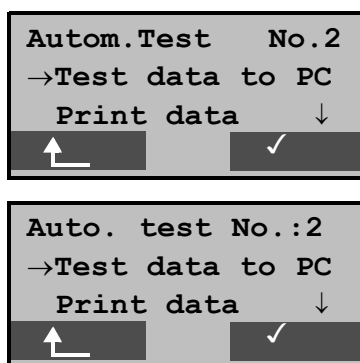

< ↓ >

< ✓ >

↶

Operation

Select *Test data to PC*

Start transfer of data to PC

Return to the *Autom. Test* menu

6.8.4 Printing the test results (optional)

With a special (optional) cable, it is also possible to print a simplified test report on a Centronics printer.

Plug the matching end of the special cable into the *L-Test* jack on the ARGUS. Plug the Centronics connector into the printer.

Now select the data record that you wish to output on the connected Centronics printer (in the following example Test No.2).

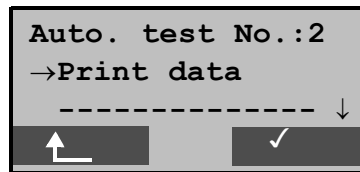

< ↓ >

< ✓ >



Operation

Select *Print data*

Start printing

Return to the *Autom. Tests menu*

While printing, the following will be shown on the display:

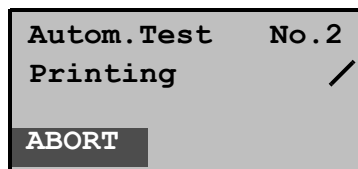

< ABORT >

Operation

Quit printing

If an error occurs while printing, the ARGUS will show “No reply” in the second line of the display; if the data is transferred properly “Transfer OK” will be displayed.

6.9 Menu: Configuration

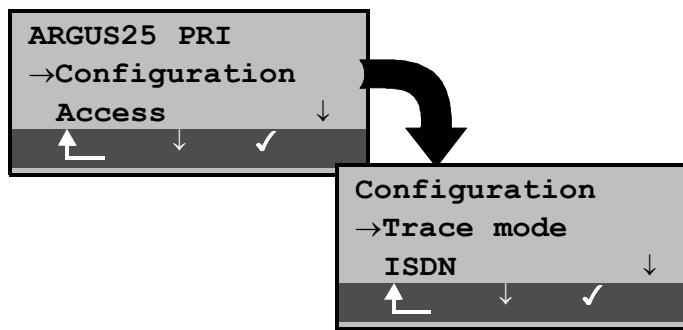

	Operation
< ↓ >	Select <i>Configuration</i>
< ✓ >	Open the <i>Configuration</i> menu
↶	Return to the status display

6.9.1 Trace mode

The ARGUS passes the recorded D-channel data to the connected PC or saves it in the internal FLASH memory.

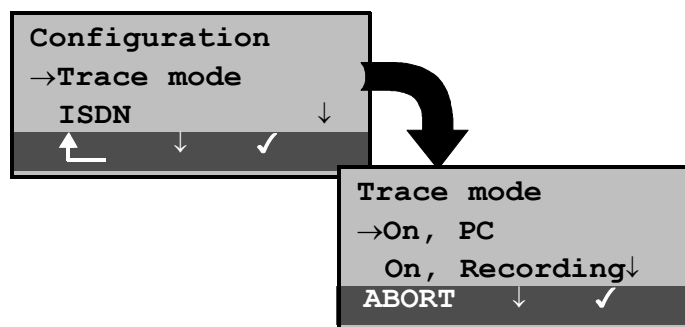

	Operation
< ↓ >	Select the <i>Trace mode</i>
< ✓ >	Open the <i>Trace mode</i> function
↶	Return to Main menu
< ↓ >	Select the <i>Trace mode</i>
< ✓ >	Accept settings and return to the <i>Configuration</i> menu

<ABORT >

Return to the *Configuration* menu without making the changes



The *Trace mode* setting is only saved temporarily. In other words, Trace mode is always off when the ARGUS is first switched on.

With the setting *Trace mode "On, PC"*, the ARGUS remains active, and sends all of its own D-channel messages and those that it receives from the network to the PC.

When the trace mode is active, the LED labeled "Trace" will be on continuously. If the ARGUS cannot send the data to the PC without errors, the LED will flash at 5Hz (5 times per sec).

In the *Trace mode "On, Recording"*, the ARGUS remains active, but saves the D-channel messages in the internal Flash memory. This trace mode setting is indicated by a slowly flashing the LED (once per sec).



The D-channel data saved in the FLASH can be loaded to the PC in the "Recorder" mode (see "BRI/PRI Recorder" on page 51).

6.9.2 Configuration: ISDN

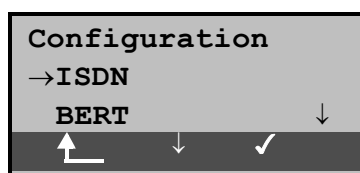

Operation

< ↓ >

Select the *ISDN config.* submenu

< ✓ >

Open the *ISDN config* submenu



Return to Main menu

6.9.2.1 Layer 1 permanent

(only on a BRI access)

On the ARGUS, you can make Layer 1 (L1) on a **BRI connection in NT mode** permanently active.

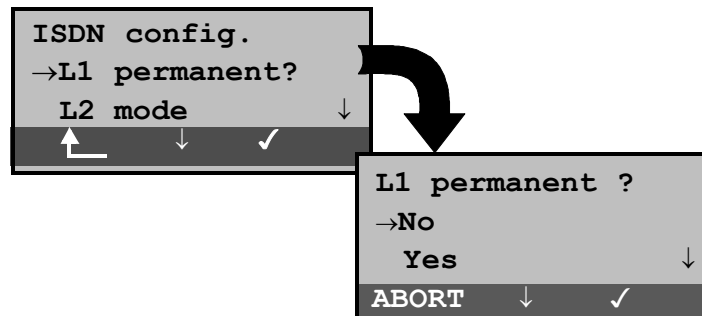

	Operation
< ↓ >	Select <i>L1 permanent?</i>
< ✓ >	Confirm your selection
⬆	Return to the <i>Configuration</i> menu
<hr/>	
< ↓ >	Select the desired L1 mode.
< ✓ >	Accept settings and return to the <i>ISDN config.</i> submenu
<ABORT >	Return to the <i>ISDN config.</i> submenu without making any changes

6.9.2.2 Select the D-channel protocol

Normally, the ARGUS will use the automatically recognized Layer 3 D-channel protocol.

However, since it is not possible to automatically recognize every protocol, the ARGUS allows you to manually select the protocol:

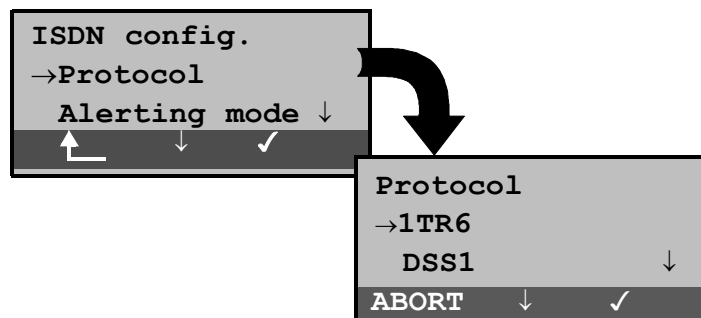

	Operation
< ↓ >	Select the <i>Protocol</i>
< ✓ >	Confirm your selection
⏪	Return to the <i>Configuration</i> menu
<hr/>	
< ↓ >	Select the Layer 3 protocol
< ✓ >	Accept settings and return to the <i>ISDN config.</i> submenu
< ABORT >	Return to the <i>ISDN config.</i> submenu without making the changes



This setting will not be saved permanently, rather only applies for the current measurement. If the ARGUS is switched off, the setting will be lost.

6.9.2.3 Alerting mode

You can specify whether, for an incoming call on a BRI point- to-point access, the ARGUS should only display the access number without extension or the complete number with extension.

If you select **Manual**, the extension can be displayed (An incoming call will be signaled. The ARGUS will send the Layer 3 message "Alert" when it accepts the call. The digits of the extension that have been sent by this point will be displayed.).



With the *Manual* setting, an incoming call must be answered within 20 seconds or it will be lost. Furthermore, you should not that the remote subscriber will not hear a ringing tone.

If you select **Automatic**, the ARGUS will only display the access number without extension or, depending on the configuration of the access in the exchange, it may not display the number called at all.

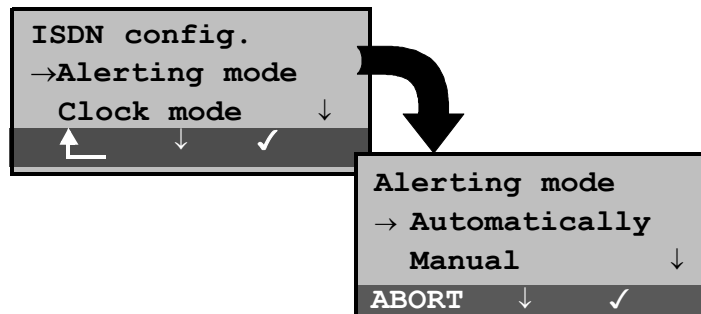

	Operation
< ↓ >	Select the <i>Alerting mode</i>
< ✓ >	Confirm your selection
⏪	Return to the <i>Configuration</i> menu
< ↓ >	Select the desired alerting mode.
< ✓ >	Accept the settings and return to the <i>ISDN config.</i> submenu
<ABORT >	Return to the <i>ISDN config.</i> submenu without making any changes

6.9.2.4 Clock mode

When the ARGUS is operated on a BRI or PRI access, you can specify where the clock is generated (regardless of whether the operation mode is TE or NT).

You can either specify that the ARGUS generates the clock (is Master) or that it is the slave of a clock generated at the other end.

In NT-Simulation, the ARGUS is by default *Master*. For a TE-Simulation or a permanent circuit, the default setting is *Slave*.

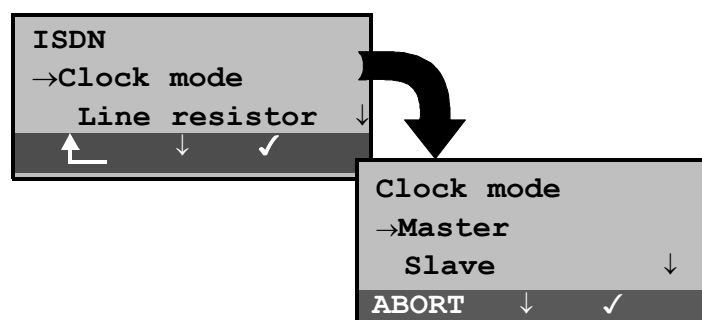

	Operation
< ↓ >	Select the <i>Clock mode</i>
< ✓ >	Open the <i>Clock mode</i> function
⬆	Return to the <i>Configuration</i> menu
<hr/>	
< ↓ >	Select the desired clock mode
< ✓ >	Accept settings and return to the <i>ISDN config.</i> submenu
< ABORT >	Return to the <i>ISDN config.</i> submenu without making any changes



This setting will not be saved permanently, rather only applies for the current measurement. If the ARGUS is switched off, the setting will be lost.

6.9.2.5 BRI termination

Independent of the operation mode (TE or NT), a terminating resistor can be switched in for the BRI access.

No terminating resistor will be switched in when the Argus is in TE-Simulation mode or on a permanent circuit. In the NT-Simulation mode, the terminating resistors are initially switched on.

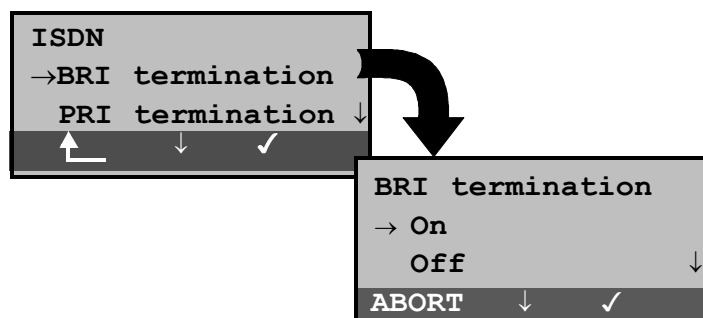

Operation	
< ↓ >	Select <i>BRI termination</i>
< ✓ >	Open <i>BRI termination</i>
⬆	Return to the <i>Configuration</i> menu
<hr/>	
< ↓ >	Select <i>On</i> or <i>Off</i>
< ✓ >	Accept the settings and return to the <i>ISDN config.</i> submenu
< ABORT >	Return to the <i>ISDN config.</i> submenu without making any changes



This setting will not be saved permanently. If the ARGUS is switched off, the setting will be lost.

6.9.2.6 PRI termination

The terminating resistance of the PRI must be set in accordance with the impedance of its cabling system (coaxial cable with 75 Ω Ohms impedance or twisted-pair cable with 120 Ω Ohms impedance).

The default setting is country-specific and corresponds to the system most common in the respective country:

Germany, Austria, England, 120 Ohm
Netherlands, France, ...

Spain, Italy, Greece, ... 75 Ohm

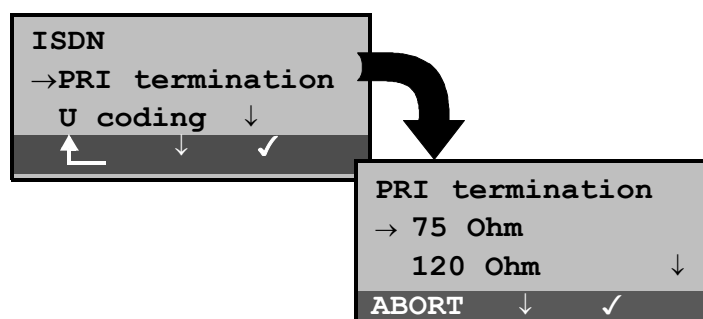

	Operation
< ↓ >	Select <i>PRI termination</i>
< ✓ >	Open the <i>PRI termination</i> function
⏪	Return to the <i>Configuration</i> menu
< ↓ >	Select the <i>value of the terminating resistor</i>
< ✓ >	Accept the settings and return to the <i>ISDN config.</i> submenu
< ABORT >	Return to the <i>ISDN config.</i> submenu without making any changes

6.9.2.7 U coding

In tests on a U-interface access, the ARGUS can set the desired coding of the U-interface (4B3T or 2B1Q).

The setting must match that of the U interface to be tested.

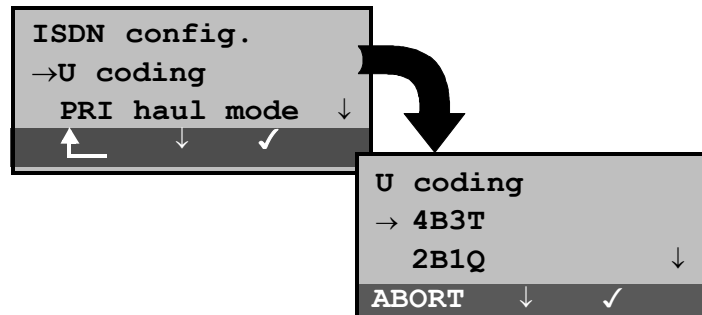

	Operation
< ↓ >	<i>U coding</i>
< ✓ >	Open the <i>U coding</i> function
⬆	Return to the <i>Configuration</i> menu
<hr/>	
< ↓ >	Select <i>4B3T</i> or <i>2B1Q</i>
< ✓ >	Accept the settings and return to the <i>ISDN config.</i> submenu
<ABORT >	Return to the <i>ISDN config.</i> submenu without making any changes

6.9.2.8 PRI Sensitivity (Haul Mode)

With this submenu, the ARGUS can set sensitivity of the PRI access.

By default, short haul will be suggested.

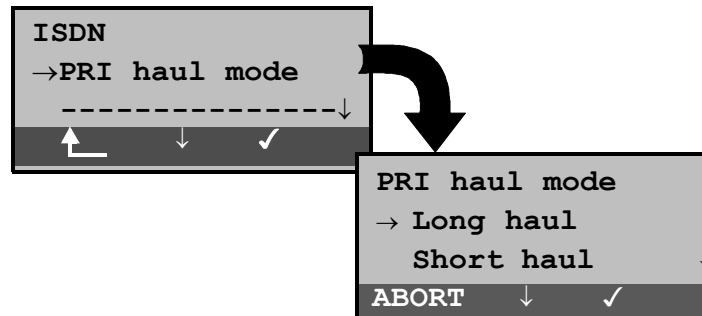

	Operation
< ↓ >	Select <i>PRI haul mode</i>
< ✓ >	Open the <i>PRI haul mode</i> function
↶	Return to the <i>Configuration</i> menu
<hr/>	
< ↓ >	Select <i>Long haul</i> or <i>Short haul</i>
< ✓ >	Accept settings and return to the <i>ISDN config.</i> submenu
< ABORT >	Return to the <i>ISDN config.</i> submenu without making any changes

Settings:

Short haul: Normal sensitivity, i.e. signal reception with cable attenuation of up to ca. -10dB.

Long haul: Increased sensitivity, i.e. signal reception with cable attenuation of up to ca. -35dB. This corresponds to a distance of 1600m with 22AWG twisted pair cable.

When using greater sensitivity (Long haul mode) on longer lines, feedback on the line can cause faulty synchronization.

6.9.2.9 Setting the Sa5 Bits

The ARGUS25 can set the Sa5 bits on a PRI access. By default, the Sa5 bits are set to 1111.

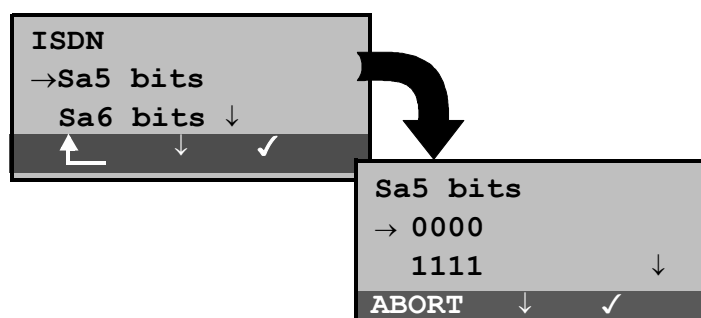

	Operation
< ↓ >	
< ✓ >	Open <i>Sa5 bits</i> function
⬆	Return to the <i>Configuration</i> menu
< ↓ >	Select <i>Sa5 bits</i> (0000 or 1111)
< ✓ >	Accept the settings and return to the <i>ISDN config.</i> submenu
<ABORT >	Return to the <i>ISDN config.</i> submenu without making any changes

Options for the Sa5 bits:

Sa5 Coding	Meaning (Network Terminal)	Meaning (Terminal Network)	-->
0000	Direction code	Acknowledgment for loop command	
1111	-----	Direction code	



The Sa5 bits have no significance between an NTPM and a PBX system.



This setting will not be saved permanently. If the ARGUS is switched off, the setting will be lost.

6.9.2.10 Setting the Sa6 Bits

The ARGUS25 can set the Sa6 bits on a PRI access. By default, the setting 1111 will be suggested.

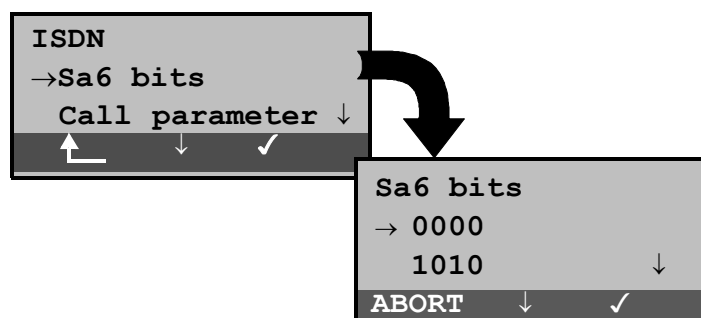

	Operation
< ↓ >	Select <i>Sa6 bits</i>
< ✓ >	Open the <i>Sa6 bits</i> function
⬆	Return to the <i>Configuration</i> menu
< ↓ >	Select the desired <i>Sa6 bits</i>
< ✓ >	Accept the settings and return to the <i>ISDN config.</i> submenu
< ABORT >	Return to the <i>ISDN config.</i> submenu without making any changes

Options for the Sa6 bits:

Sa6 Coding	Meaning (Network --> Terminal)	Meaning
0000	Setting for normal operation (default)	Setting for normal operation, idle (default)
1010	Switches a loop in the NTPM. In the permanent circuit mode, a BERT can then be performed using the loop setup there. Important: The ARGUS must be set to “ Permanent switch ” even if it is a dial-up access!	_____

- 1111 Switches a loop in the AIS on U2an of the NTPM. In the permanent circuit mode, a BERT can then be performed using the loop setup there. Important: The ARGUS **must** be set to “**Permanent switch**” even if it is a dial-up access!



The Sa6 bits have no significance between an NTPM and a PBX system.



This setting will not be saved permanently. If the ARGUS is switched off, the setting will be lost.

6.9.2.11 Call Parameter

Two different parameters can be set for (ISDN) calls generated on both the network-side (ARGUS in NT mode) and on the user-side (ARGUS in TE mode):

- **Type Of Number (TON)** for the CGN (=CGPN) or CDN (=CDPN) element of a SETUP signal
- The **Numbering Plan (NP)** for the CGN (=CGPN) or CDN (=CDPN) element of a SETUP signal

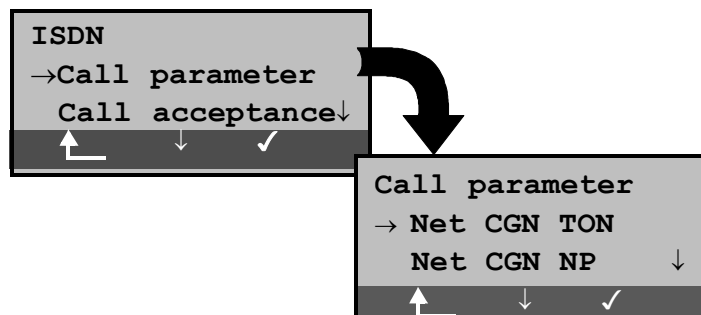

Operation

- < ↓ > Select *Call parameter*
- < ✓ > Open the *Call parameter* menu
- ⏪ Return to the *Configuration* menu

- < ↓ > Select desired function:
 - **Network-side: Net CGN TON /Net CDN TON**
User-side: User CGN TON /User CDN TON
 Set the **Type Of Number (TON)** for the CGN or CDN element of a SETUP signal
 - **Network-side: Net CGN NP /Net CDN NP**
User-side: User CGN NP /User CDN NP
 Set the **Numbering Plan (NP)** for the CGN or CDN element of a SETUP signal
- < ✓ > Open the selected function
- ↶ Return to the *ISDN* menu

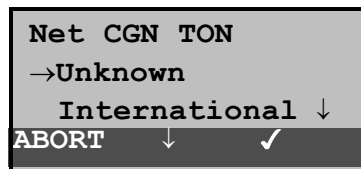

- Operation**
- < ↓ > Select the desired setting
 - < ✓ > Accept settings and return to the *Call parameter* menu
 - <ABORT > Return to the *Call parameter* menu without making any changes

Possible settings:

For TON: unknown, international, national, network spec., subscriber, abbreviated.

For NP: unknown, ISDN/telephony, data, telex, national stand., private

6.9.2.12 Call Acceptance

In TE mode on a P-MP access, the ARGUS can either signal all incoming calls or just those calls whose destination address matches the MSN of the access under test.

The function is only available, when your own call number has been saved in the speed-dialing memory under “own number” (see section 6.9.6 Saving Call Numbers page 165) and the incoming call has a destination MSN.

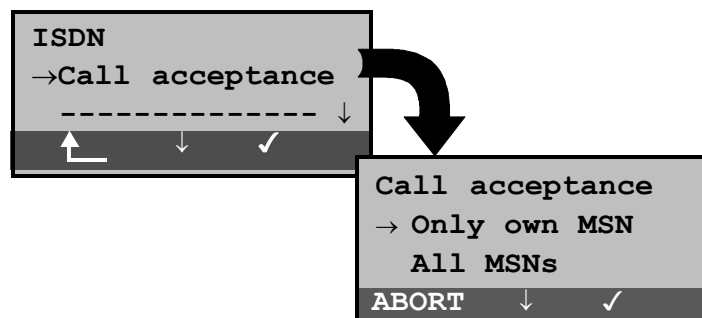

	Operation
< ↓ >	Select <i>Call acceptance</i>
< ✓ >	Open the <i>Call acceptance</i> function
↶	Return to the <i>Configuration</i> menu
< ↓ >	Select the desired setting: Only own MSN: The ARGUS signals the incoming call, if its destination MSN matches your “own” number. All MSNs: The ARGUS signals all calls
< ✓ >	Accept the settings and return to the <i>ISDN config.</i> submenu
< ABORT >	Return to the <i>ISDN config.</i> submenu without making any changes

By default, this is set to *All MSNs*.

This setting will be saved permanently.

6.9.3 Configuration: BERT

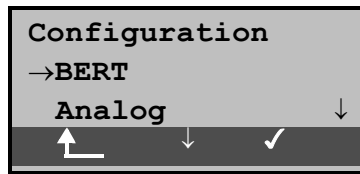

< ↓ >

< ✓ >

↑

Operation

Select the *BERT* submenu

Open the *BERT* submenu

Return to the Main menu

6.9.3.1 BERT - duration

The default setting for the bit error rate test's measurement time is 1 minute. The measurement time may be set to a maximum of up to 99:59 (99 hours and 59 minutes) or an unlimited time (by entering 00:00).



If you select an unlimited measurement time, the test will **not** stop automatically, rather it must be stopped by the user (see section 6.6.6.1 page 97).

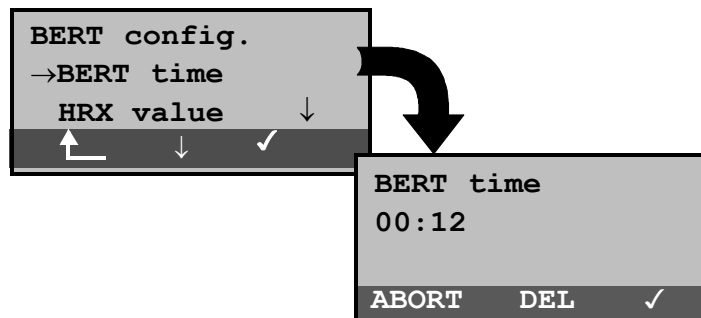

	Operation
< ↓ >	Select <i>BERT time</i>
< ✓ >	Open the <i>BERT time</i> function
⌵	Return to the <i>Configuration</i> menu
< DEL >	Delete the digit before the cursor
01 02 03 04 05 06 07 08 09 0* 00 #	Enter the desired duration of the bit error rate test
< ✓ >	Accept settings and return to the menu <i>Configuration/BERT</i>
<ABORT>	Return to the <i>Configuration/BERT</i> menu without changing the time.

6.9.3.2 HRX value

Here the HRX value is set in % (**H**ypothetical **R**eference **C**onnections ITU-T G.821):

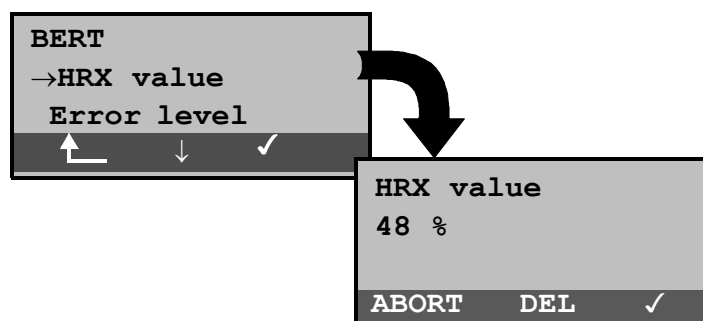

Operation	
< ↓ >	Select <i>HRX value</i>
< ✓ >	Open the <i>HRX value</i> function
⬆	Return to the <i>Configuration</i> menu
<hr/>	
< DEL >	Delete the digit before the cursor
1 2 3 4 5 6 7 8 9 * 0 #	Enter the desired HRX value Values from 0 to 100 %
< ✓ >	Accept the HRX value and return to the <i>Configuration/BERT</i> menu.
<ABORT>	Return to the <i>Configuration/BERT</i> menu without changing the HRX value.

6.9.3.3 BERT - Setting the Error Level

The default threshold (error level) is 10^{-06} . That means that, in the event that the bit error rate is less than 10^{-06} (one error in $10^6 = 1,000,000$ sent bits), the bit error test will be evaluated as OK.

If the bit error rate is greater than the error level value, the ARGUS will display NO. This parameter can be set to any value from 01 (= 10^{-01}) to 99 (= 10^{-99}).

Operation	Description
< ↓ >	Select <i>Error level</i>
< ✓ >	Open <i>Error level</i> function
↶	Return to the <i>Configuration</i> menu
< DEL >	Delete the digit before the cursor
① ② ③ ④ ⑤ ⑥ ⑦ ⑧ ⑨ ⑩ * #	Enter desired value for the error level: 01 (= 10^{-01}) to 99 (= 10^{-99})
< ✓ >	Accept settings and return to the <i>Configuration/BERT</i> menu
< ABORT >	Return to the <i>Configuration/BERT</i> menu without making any changes.

6.9.3.4 Selecting the BERT bit pattern

There are two predefined bit patterns available. Additionally, it is also possible to enter a 16 bit long pattern of your choice in binary.

The default pattern is $2^{15}-1$.

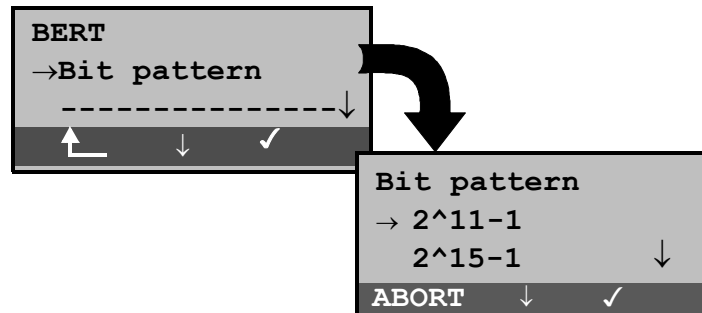

	Operation
< ↓ >	Select the <i>Bit pattern</i> function
< ✓ >	Open the <i>Bit pattern</i> function
↶	Return to the <i>Configuration</i> menu
< ↓ >	Select the desired bit pattern
< ✓ >	Accept settings and return to the <i>Configuration/BERT</i> menu
< ABORT >	Return to the <i>Configuration/BERT</i> menu without making any changes.

If a "user-defined" bit pattern is selected, an entry mask will be displayed.

A 16 bit long pattern can be entered here in binary.

In the BERT, the ARGUS will then either send this bit pattern cyclically or compare it with the received bit pattern.

```

Test pattern:
Enter:
0011010000111001
ABORT ← ✓

```

Operation



Moves the cursor to the left. The digit selected by the cursor can be directly overwritten.



Enter the desired bit pattern in binary



Accept settings and return to the *Configuration/BERT* menu.

The entered bit pattern will be stored in the non-volatile memory (EEPROM), so that it will still be available after the ARGUS has been switched off and back on.



Return to the *Configuration/BERT* menu without changing the bit pattern.

6.9.4 Configuration: Analog

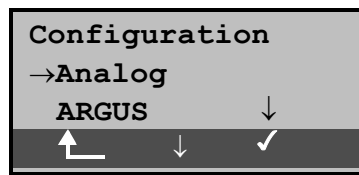

Operation	
< ↓ >	Select the <i>Analog config.</i> submenu
< ✓ >	Open the <i>Analog config.</i> submenu
↑	Return to the Main menu

6.9.4.1 Analog dial mode

On an analog access, there are two methods available for dialing (DTMF and pulse dialing):

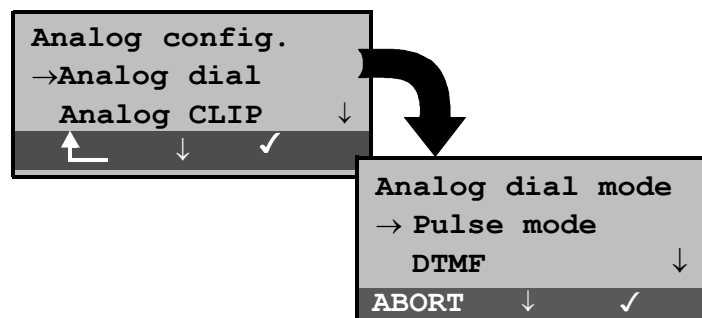

Operation	
< ↓ >	Select the <i>Analog dial mode</i> function *.*
< ✓ >	Open the <i>Analog dial mode</i> function
↑	Return to the <i>Configuration</i> menu
< ↓ >	Mark the desired dialing mode.
< ✓ >	Confirm the entry and return to the <i>Analog config.</i> menu
<ABORT >	Return to the <i>Analog config.</i> menu without changing the dialing mode

6.9.4.2 Analog CLIP

With the ARGUS, you can choose from two different methods for transferring the call number on an analog access:

- **FSK** CLIP via a method similar to a modem:
for Germany as well as some other parts of Europe
- **DTMF** CLIP via DTMF:
for Scandinavia and the Netherlands
The ARGUS will automatically detect that a CLIP was sent using DTMF *with the polarity reversal* and will set itself accordingly (e.g. Netherlands).

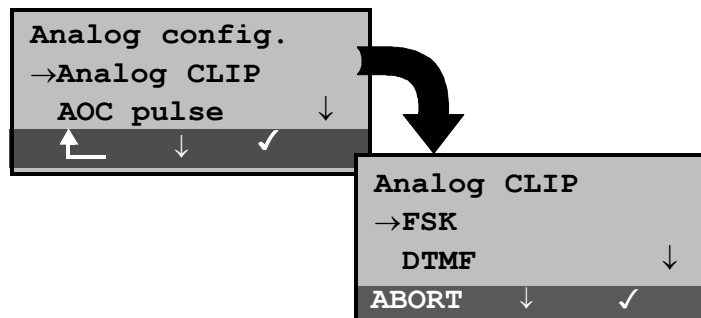

	Operation
< ↓ >	Select the <i>Analog CLIP</i> function
< ✓ >	Open the <i>Analog CLIP</i> function
⏪	Return to the <i>Configuration</i> menu
<hr/>	
< ↓ >	Select the desired CLIP method
< ✓ >	Accept settings and return to the <i>Analog config.</i> menu
< ABORT >	Return to the <i>Analog config.</i> menu without making any changes

6.9.4.3 Analog Message

The ARGUS can interpret messages received on an analog access (assuming that they are known and free of errors) or transparently display them.

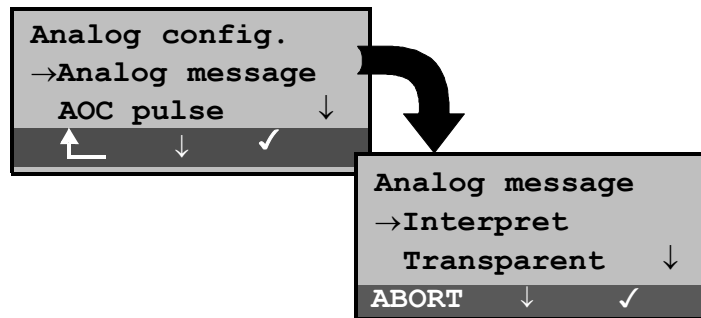

	Operation
< ↓ >	Select the <i>Analog message</i> function
< ✓ >	Open the <i>Analog message</i> function
⬆	Return to the <i>Configuration</i> menu
<hr/>	
< ↓ >	Select the desired setting
< ✓ >	Accept settings and return to the <i>Analog config.</i> menu
< ABORT >	Return to the <i>Analog config.</i> menu without making any changes

6.9.4.4 AOC pulse

On an analog access, the country-specific AOC pulse can be selected (12 or 16 kHz).

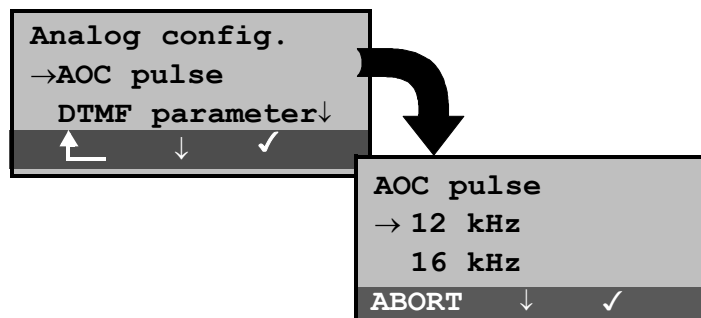

	Operation
< ↓ >	Select the <i>AOC pulse</i>
< ✓ >	Confirm your selection
⏪	Return to the <i>Configuration</i> menu
<hr/>	
< ↓ >	Select <i>12kHz</i> or <i>16kHz</i>
< ✓ >	Accept settings and return to the <i>Analog config.</i> menu
<ABORT>	Return to the <i>Analog config.</i> menu without making the changes

6.9.4.5 DTMF parameter

The ARGUS can set the parameters *Level*, *Duration* and *Interval* of the DTMF signals that are generated during analog operation.

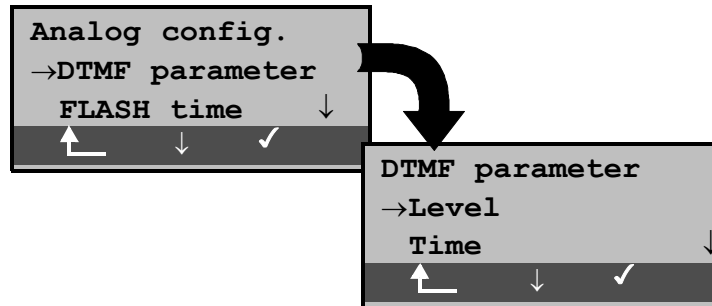

Operation	
< ↓ >	Select the <i>DTMF parameter</i> function
< ✓ >	Open the <i>DTMF parameter</i> function
↶	Return to the <i>Configuration</i> menu

Setting the DTMF level:

The default value is 0dB. The level can take a value between -21dB and +12 dB and can be raised or lowered by 3dB.

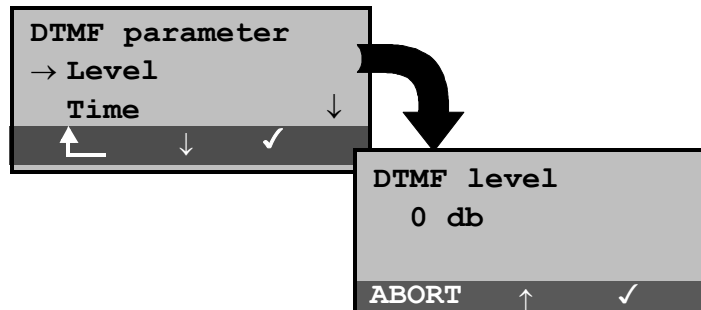

	Operation
< ↓ >	Select the <i>Level</i> function
< ✓ >	Confirm your selection
↶	Return to the <i>Analog config.</i> menu
↓ -Key	To lower the level by 3dB
< ↑ > or ↑ -Key	To raise the level by 3dB
< ✓ >	Accept settings and return to the <i>DTMF</i> submenu
< ABORT >	Return to the <i>DTMF</i> submenu without making the changes

Setting the duration of the DTMF signal:

The default setting is 80ms. The duration of the signal can take a value between 40ms and 1s. The duration can be raised or lowered using the arrow keys as follows:

In the range 40...200ms	in 10ms increments
In the range 200...300ms	in 20ms increments
In the range 300...1000ms	in 100ms increments

When the upper limit is reached (1000ms), the softkey <↑> will automatically change to a <↓> and vice versa when the lower limit (40ms) is reached.

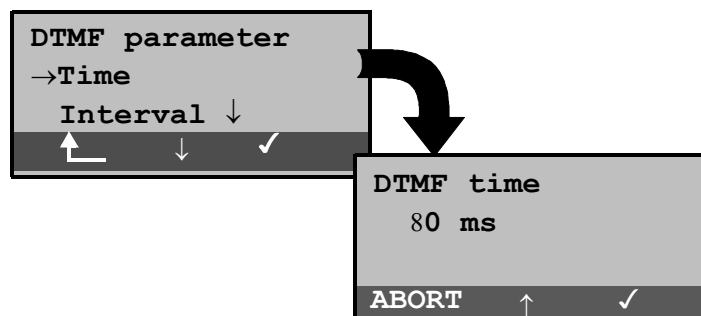

	Operation
<↓>	Select the <i>Time</i>
<✓>	Confirm your selection
↶	Return to the <i>Analog config.</i> menu
↓-Key	Lower the duration
<↑> or ↑-Key	Increase the duration
<✓>	Accept settings and return to the <i>DTMF</i> submenu
<ABORT>	Return to the <i>DTMF</i> submenu without making the changes

Setting the interval between two DTMF characters:

The default value is 80ms. The interval between two DTMF characters can take a value between 40ms and 1s. The interval can be raised or lowered by using the arrow keys as follows:

In the range 40...200ms	in 10ms increments
In the range 200...300ms	in 20ms increments
In the range 300...1000ms	in 100ms increments

When the upper limit is reached (1000ms), the softkey <↑> will automatically change to a <↓> and vice versa when the lower limit (40ms) is reached.

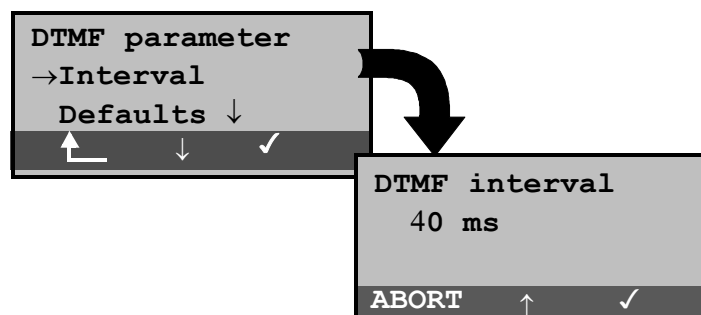

	Operation
<↓>	Select the <i>DTMF interval function</i>
<✓>	Confirm your selection
↶	Return to the <i>Analog config.</i> menu
↓-Key	Lower the <i>DTMF interval</i>
↑ or ↑-Key	Raise the <i>DTMF interval</i>
<✓>	Accept settings and return to the <i>DTMF parameter</i> submenu
<ABORT>	Return to the <i>DTMF parameter</i> submenu without making the changes

Restore the defaults:

The following defaults can be restored at any time:

- Level = 0 dB
- Time = 80 ms
- Interval = 80 ms

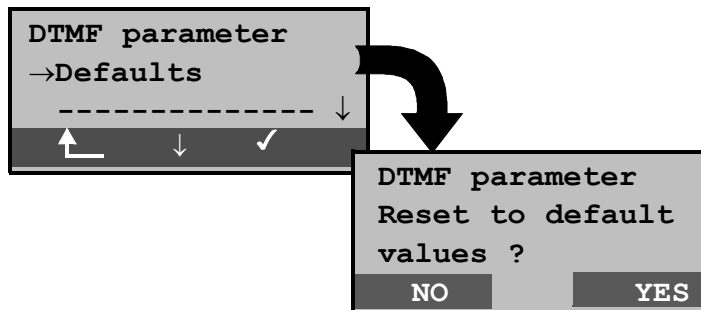

Operation	
< ↓ >	Select the <i>Defaults</i> function
< ✓ >	Confirm your selection
↶	Return to the <i>Analog config.</i> menu
<Continue >	Reset to default settings and return to the <i>DTMF parameter</i> menu

6.9.4.6 FLASH time

With this selection, you can set the length of a flash in analog operation. The FLASH time can take a value between 40ms and 1s. The duration can be raised or lowered using the arrow keys as follows:

In the range 40...200ms in 10ms increments
 In the range 200...300ms in 20ms increments
 In the range 300...1000ms in 100ms increments

When the upper limit is reached (1000ms), the softkey <↑> will automatically change to a <↓> and vice versa when the lower limit (40ms) is reached.

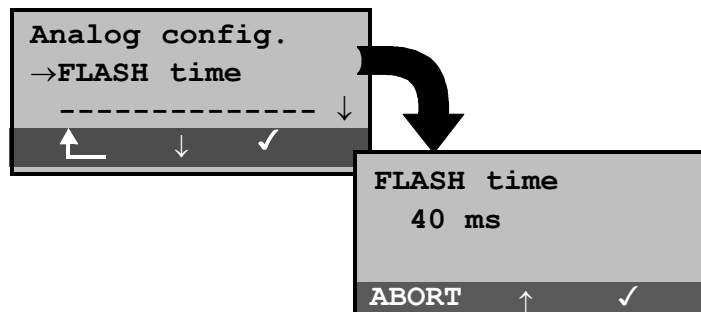

	Operation
<↓>	Select the <i>FLASH time</i> function
<✓>	Confirm your selection
↶	Return to the <i>Analog config.</i> menu
↓-Key	Lower the FLASH time
<↑> or ↑-Key	Raise the FLASH time
<✓>	Accept settings and return to the <i>Analog config.</i> menu
<ABORT>	Return to the <i>Analog config.</i> menu without making the change

6.9.5 Configuration: ARGUS

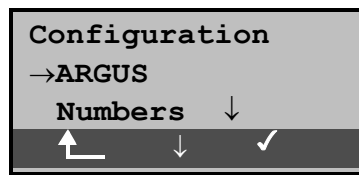
**Operation**

- < ↓ > Select the *ARGUS* submenu
- < ✓ > Open the *ARGUS* submenu
- ⬆ Return to the Main menu

6.9.5.1 Selecting the menu language

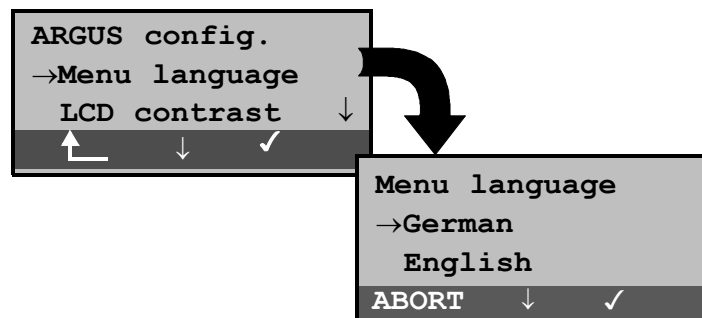
**Operation**

- < ↓ > Select the *Menu language* function
 - < ✓ > Open the *Menu language* function
 - ⬆ Return to the *Configuration* menu
-
- < ↓ > Select the desired language
 - < ✓ > Confirm the selection and return to the *ARGUS config.* menu
 - < ABORT > Return to the *ARGUS config.* menu without making the change

6.9.5.2 Setting the display contrast

The contrast of the ARGUS display can be adjusted to suit the individual user. The contrast can be adjusted in 16 steps.

In the third line, the display shows a vertical arrow, which shows the current setting on a scale from low to high contrast.

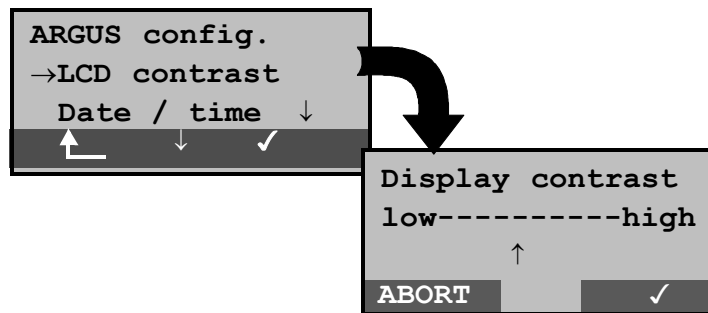

	Operation
< ↓ >	Select the <i>LCD contrast</i> function
< ✓ >	Open the <i>LCD contrast</i> function
⏪	Return to the <i>Configuration</i> menu
↓ -Key	Decrease contrast
↑ -Key	Increase contrast
< ✓ >	Change the LCD contrast and return to the <i>ARGUS config.</i> menu
< ABORT >	Return to the <i>ARGUS config.</i> menu without making the change

6.9.5.3 Date / Time

Any date and time can be entered. The ARGUS will use these settings on the D-channel in the NT mode of operation and in the **automatic test**.

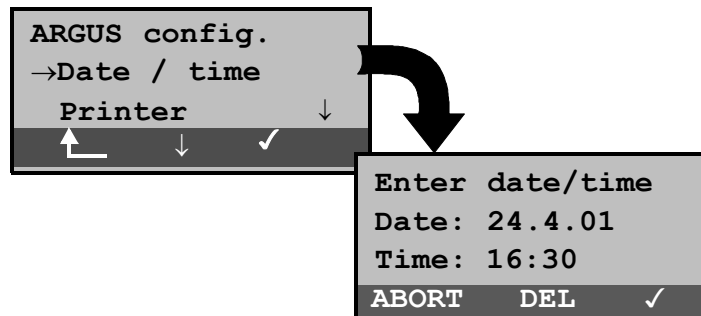

	Operation
< ↓ >	Select the <i>Date / time</i> function
< ✓ >	Open the <i>Date / time</i> function
↶	Return to the <i>Configuration</i> menu
1 2 3 4 5 6 7 8 9 * 0 #	Enter the desired date
↓ -Key	Switch to the Time line
1 2 3 4 5 6 7 8 9 * 0 #	Enter the desired time
	Delete the digit before the cursor
< ✓ >	Confirm the entries and return to the <i>ARGUS config.</i> menu
<ABORT>	Return to the <i>ARGUS config.</i> menu without making the changes

The entered date will be saved in the ARGUS and will be suggested as the default the next time that the *Enter date/time* function is used.

The entered time will be continuously updated by the ARGUS's real time clock as long as the power is not switched off.

When the power is switched off (the ARGUS switched off without batteries), the clock will run a few more weeks on its internal supply. When the backup supply is exhausted, the time will be undefined.

6.9.5.4 Handset

The ARGUS makes a distinction between the integrated handset and an external headset:

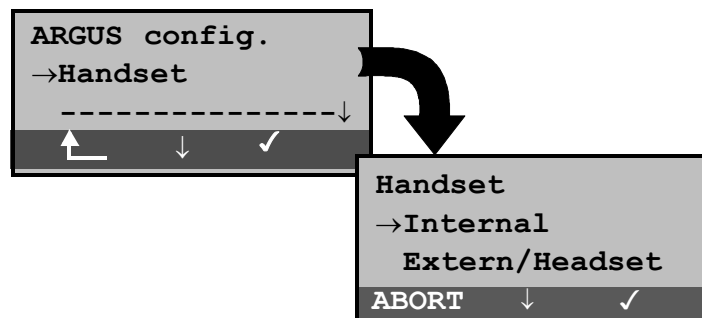

	Operation
< ↓ >	Select the <i>Handset</i> function
< ✓ >	Open the <i>Handset</i> function
↶	Return to the <i>Configuration</i> menu
<hr/>	
< ↓ >	Select the desired handset
< ✓ >	Accept the settings and return to the <i>ARGUS config.</i> menu
< ABORT >	Return to the <i>ARGUS config.</i> menu without making the change

With the softkey, an existing connection can be switched back and forth between an external headset and the integrated handset (see “Setting up an ISDN connection” on page 63).

6.9.5.5 Printer

This function is used to set the printer options. The default is ARGUS EPSON LQ.

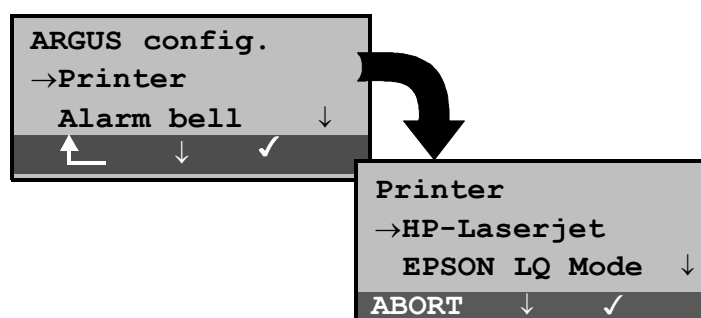

Operation	
< ↓ >	Select the <i>Printer</i> function
< ✓ >	Open the <i>Printer</i> function
↶	Return to the <i>Configuration</i> menu
<hr/>	
< ↓ >	Select desired printer
< ✓ >	Accept the settings and return to the <i>ARGUS config.</i> menu
< ABORT >	Return to the <i>ARGUS config.</i> menu without making the change

If you wish to use a printer that is not compatible with either the HP-Laserjet or the EPSON LQ, select the *ESC sequence*.

An entry mask will open in which you can enter an ESC-sequence character-by-character, which will permit the optimum adaptation to your printer.

Up to 9 different ESC sequences can be entered and saved in the EEPROM in the ARGUS so that these will still be available after the ARGUS has been switched off and then back on.

```

ESC sequence 1
Enter:
#14#78#89#128
ABORT  DEL  ✓

```

< DEL >

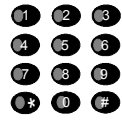

< ✓ >

<ABORT>

Operation

Delete the digit before the cursor

Enter the ESC sequence (see the information from the manufacturer of your printer) in decimal format. The character codes are each separated by a "#".

Save the entered ESC sequence in EEPROM. The display is setup for the entry of the next ESC sequence.

Return to the *Configuration* menu

6.9.5.6 Alarm bell

The ARGUS signals with an alarm in a variety of situations, e.g. when a bit error occurs in a BERT. With the *Alarm bell* function, you can suppress all audible alarms.

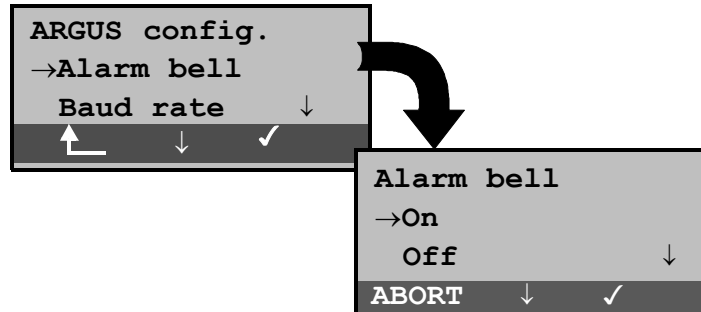

	Operation
< ↓ >	Select the <i>Alarm bell</i> function
< ✓ >	Open the <i>Alarm bell</i> function
⬆	Return to the Configuration menu
<hr/>	
< ↓ >	Select the desired setting
< ✓ >	Accept the settings and return to the <i>ARGUS config.</i> menu
< ABORT >	Return to the <i>ARGUS config.</i> menu without making the change

This setting is not lost when the ARGUS is switched off and back on again.

6.9.5.7 Baud Rate

There is a selection of baud rates available for use when connecting the ARGUS to a PC.

The default setting is 57600 baud.

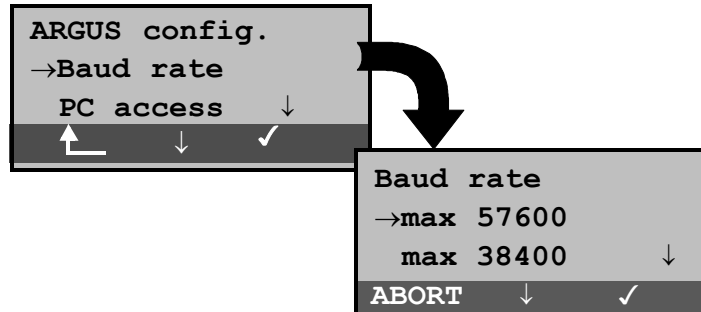

	Operation
< ↓ >	Select the <i>Baud rate</i> function
< ✓ >	Open the <i>Baud rate</i> function
↶	Return to the Configuration menu
<hr/>	
< ↓ >	Select the desired setting
< ✓ >	Confirm the entered baud rate and return to the <i>ARGUS config.</i> menu
< ABORT >	Return to the <i>ARGUS config.</i> menu without changing the baud rate

6.9.5.8 PC Access

The data can be transferred between the ARGUS and a PC via the serial interface or cordlessly via the IrDa infrared interface.

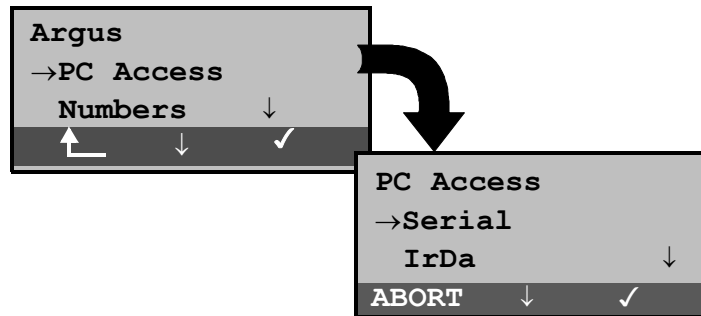

	Operation
< ↓ >	Select the <i>PC access</i> function
< ✓ >	Open the <i>PC access</i> function
⬆	Return to the Configuration menu
<hr/>	
< ↓ >	Select desired access
< ✓ >	Confirm the entries and return to the <i>ARGUS config.</i> menu
< ABORT >	Return to the <i>ARGUS config.</i> menu without making any changes



A software update of the ARGUS can only be made over the serial interface.

6.9.6 Saving Call Numbers

Ten call numbers with a maximum of 24-places can be entered in the speed dialing memory.



The first number **must** be the **own** call number of the access under test (this is especially important for the automatic Service test).

In the *Remote No.1-8* memory locations, you can save whichever remote call numbers you wish. In the memory location *X.31 test number*, the ARGUS expects the entry of the X.25 access number for the X.31 test (see section 6.6.7 page 105).

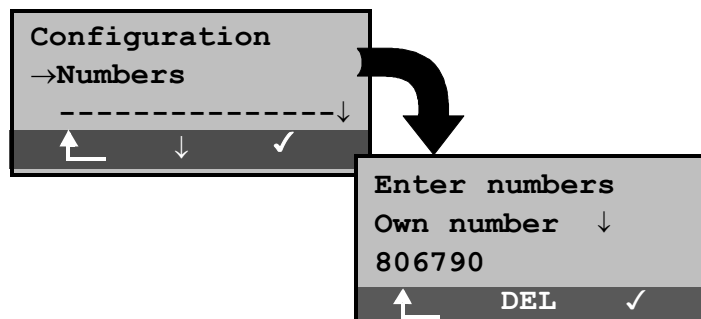

	Operation
< ↓ >	Select the <i>Enter numbers</i> function
< ✓ >	Open the <i>Enter numbers</i> function
↶	Return to the Main menu
1 2 3 4 5 6 7 8 9 * 0 #	Enter the desired number The first number must be the own call number of the access under test.
↓ -Key	Scroll to the next speed dialing memory and enter the next number
< ✓ >	Save call numbers. The display is setup for the entry of the next call number.
< DEL >	Delete the digit before the cursor
↶	Return to the <i>Configuration</i> menu

When entering a call number with an extension (operation of the ARGUS on a PBX access) observe the following:

The extension is separated from the access number by a #.

For outgoing calls, the ARGUS uses the entire call number (without #) as the number called (CDPN or DAD) and, for the calling number (DSS1-CGPN or 1TR6-OAD), only the number after the #, in other words the extension. A "#" at the beginning of a call number is treated as a valid character.

An example:

02351/9970-45 is entered as 023519970#45



If the “#” is at the end of a number, when the number is later dialed it will be done without CGPN or OAD. This is important for some PBXs.

6.9.7 Reset

The ARGUS resets all of the settings or entries made in the *Configuration* menu back to their default values.



The speed-dialing memory and the results of all of the automatic tests will be deleted.

The following settings are possible:

	Default	
BERT time	1 min	
BERT error level	10^{-06}	
BERT bit pattern	$10^{15}-1$	
BERT-HRX	15%	
“User defined”	bit 0000000000000000	
pattern		
PRI terminating resistance	100 Ohm	only for PRI
PRI sensitivity (haul mode)	Short haul	only for PRI
Alerting mode	Automatic	
Call acceptance	All MSNs	
L1 permanent?	No	only for BRI NT

Clock mode	For NT, <i>Master</i> For TE, <i>Slave</i>
U coding	Depends on country (national variant)
Analog dial mode	DTMF
Analog CLIP	FSK
Analog AOC pulse	16 kHz
Analog FLASH time	80 msec
DTMF parameter	80ms/80ms/0dB
Menu language	Depends on country (national variant)
LCD contrast	Average value
Date	1.1.2000 / 12:00
Headset	Internal
Printer	EPSON LQ
ESC sequence (Printer)	none
Baud rate	57.600
Alarm bell	Off
Call numbers 0-9	All memory locations empty
Auto Test results	All memory locations empty

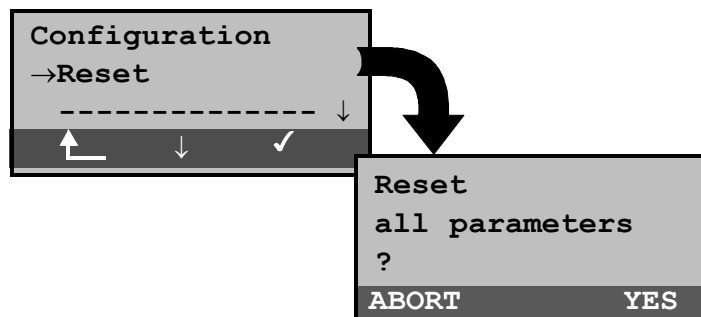

	Operation
< ↓ >	Select the <i>Reset</i> function
< ✓ >	Open the <i>Reset</i> function
⏪	Return to the Main menu
< YES >	After prompting you to confirm that you are sure, the ARGUS will reset all of its settings.
< ABORT >	Return to the <i>Configuration</i> submenu without resetting the parameters.

6.10 Menu: Level measuring

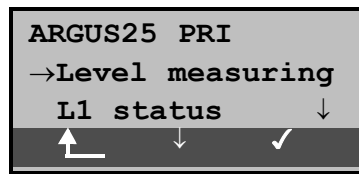

Operation

- < ↓ > Select the *Level measuring* menu
- < ✓ > Open the *Level measuring* menu
- ↑ Return to the status display

6.10.1 Level measuring on a BRI access

- **Level measurement – connected line**

The ARGUS measures the level of the received useful signal. In TE mode, it also measures the phantom feed. The measurement will be updated continuously.

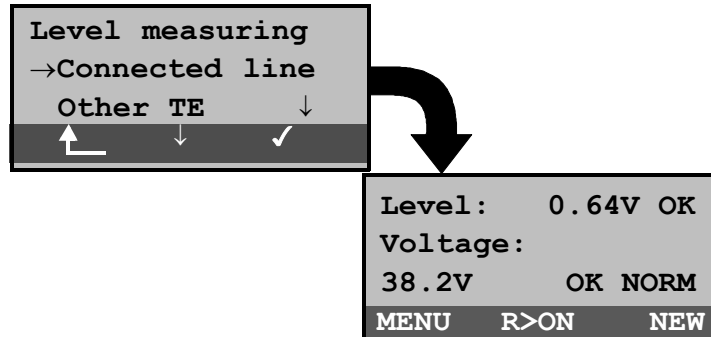

Operation	
< ↓ >	Select the <i>Connected line</i> (remote end)
< ✓ >	Start the <i>Connected line</i> function
↶	Return to the Main menu
< NEW >	Layer 1 will setup again to ensure a proper measurement on a Layer 1 that is not permanently active
< MENU >	Return to the <i>Level measuring</i> menu
<R>ON> or	Add or remove a 100Ω resistor.
<R>OFF>	

Measurement results:

First line: The level of the useful signal in volts. An evaluation of the level follows:
 << level is too low
 >> level is too high
 OK level is in order (0.75V ^{+20%}_{-.33%})
 __ no voltage

Third line: The level of the feed in volts. An evaluation of the level follows.
 Afterwards, the type of supply will be displayed:
 NORM normal feed (40V ^{+4.25%}_{-.13.75%})
 REV_ inverted phantom feed
 NONE no feed

- **Level measurement - other TE**

In TE mode, the ARGUS will measure the level of a terminal connected in parallel. In this case, the ARGUS is **passive**.

Layer 1 must be active on the terminal, whose level will be measured. The ARGUS updates its measurement continuously.

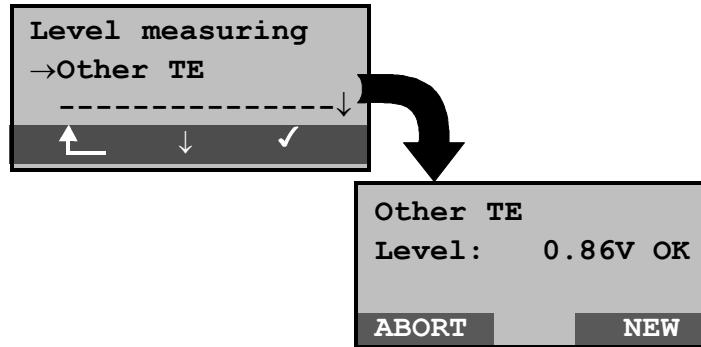

Operation	
< ↓ >	Select <i>Other TE</i>
< ✓ >	Confirm your selection
↶	Return to the Main menu
<hr/>	
< MENU >	Return to the <i>Level measuring</i> menu

Measurement results: The level of the useful signal in volts.



This measurement is only possible when the ARGUS is **not** supplied by the BRI.

6.10.2 Level measurement on a U interface

- **Measurement of feed voltage - U interface**

The ARGUS measures the level of the feed voltage. The measurement will be updated continuously.

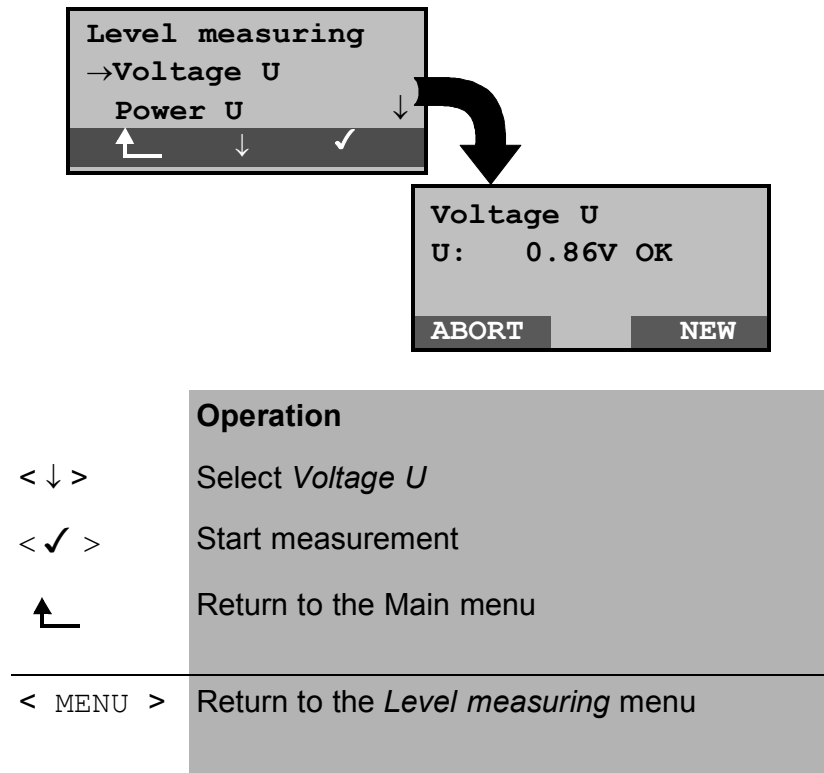

Measurement results: The level of the supply in volts.

- **Measurement of the U interface under load**

With this function, you can use the ARGUS to apply an incremental load to the U interface.

The ARGUS measures the voltage and also displays the calculated current and power.

From these values, it is possible to estimate the length of the line.

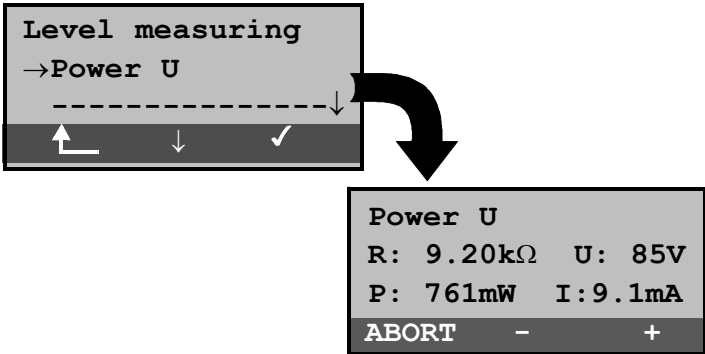

The diagram illustrates the menu navigation process. It starts with a 'Level measuring' menu where 'Power U' is selected. An arrow points to a 'Power U' menu displaying measurement results: R: 9.20kΩ, U: 85V, P: 761mW, I: 9.1mA. Below this is a table of operations.

Operation	
< ↓ >	Select <i>Power U</i>
< ✓ >	Start measurement
↶	Return to the Main menu
<hr/>	
< + >	The load will be increased by one increment (the resistance is lowered)
< - >	The load will be lowered by one increment (the resistance is increased)
<ABORT>	Return to the <i>Level measuring</i> menu

Measurement results:

Second line: The load in kΩ and the measured voltage (should not be > 100V).

Third line: The calculated power in mW plus the calculated current in mA.

Step	Load / kΩ	Maximum Voltage / V
1	64	ca. 126.0 ¹⁾
2	28	ca. 126.0 ¹⁾
3	19	ca. 114.0 ¹⁾
4	14	ca. 114.0 ¹⁾
5	11	ca. 114.0 ¹⁾
6	9	ca. 109.4 ²⁾
7	8	ca. 101.8 ²⁾
8	7	ca. 94.6 ²⁾
9	6	ca. 75.0 ¹⁾
10	5.5	ca. 75.0 ¹⁾
11	5	ca. 75.0 ¹⁾
12	4.5	ca. 75.0 ¹⁾
13	4.2	ca. 73.9 ²⁾
14	3.9	ca. 71.2 ²⁾
15	2.7	ca. 59.5 ²⁾

¹⁾ The voltage is limited by the power capacity of the individual components in the ARGUS

²⁾ The voltage is limited by the maximum power (1300mW) of the U-interface

When switching the load levels, the power limitations of the components within the ARGUS and the maximum permissible power (1300mW) of the U-interface must be taken into consideration. Therefore, the ARGUS will only permit the load to be switched another increment when the specified voltage will not be exceeded.

6.10.3 Level measuring on an analog access

The ARGUS measures the voltage level in both the normal case and when the line is “busy” (trunk line).

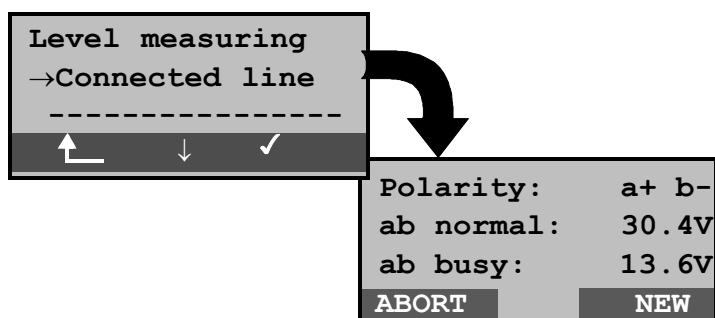

Operation	
< ↓ >	Select the <i>Connected line</i> (remote end)
< ✓ >	Start measurement
↶	Return to the Main menu
<ABORT>	Return to the <i>Level measuring</i> menu

Measurement results:

First line: The polarity of the analog line (2 wire)
 Red plug: a
 Black plug: b

Second line: The normal voltage level

Third line: The voltage level when the line is “busy”

The measurement will be updated continuously.

6.11 Menu: L1 status

This menu consists of a single function:

- To display the Layer 1 parameters when the ARGUS is operated on a PRI access
- To display the Layer 1 status when the ARGUS is operated on a BRI access

6.11.1 The L1 status of a BRI access

The ARGUS displays in TE mode the current status of Layer 1: which signal is received from the remote end (Rx) and which signal the ARGUS sends (Tx).

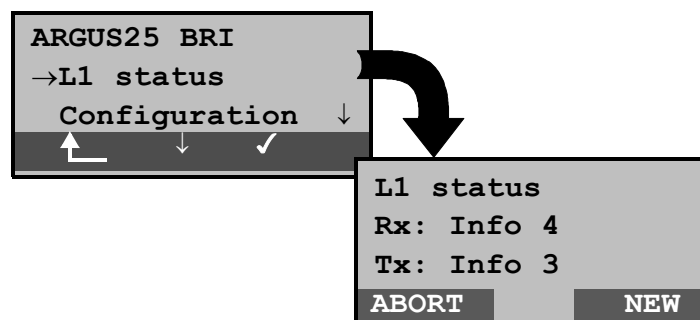

	Operation
< ↓ >	Select the <i>L1 status</i> menu
< ✓ >	Open the <i>L1 status</i> menu
↶	Return to the status display
< NEW >	Layer 1 will be setup, if it is not already
<ABORT >	Return to the Main menu

The ARGUS displays the status of Layer 1 or of the signal, which is being sent (Info 0 Info 4).

6.11.2 The L1 status of a PRI access

In this menu, the Layer 1 alarms and messages are presented in several windows, which permit detailed statements regarding the state of the PRI access and the transmission line (For further information, see the CCIT/ITU guidelines G.703 and G.704).

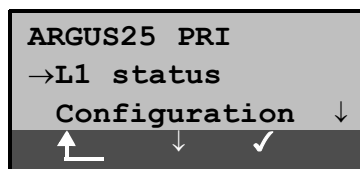

You can scroll between the various windows.

The measurement time and all the parameters will be updated automatically.

On the first line, you will find the time (in minutes and seconds) that has elapsed since the ARGUS was initially started or since it was last reset.

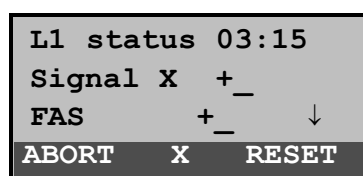

Operation

- < ↓ > Scroll through the display
- < X > The PRI relay for the Rx/Tx pin assignment will be toggled to its other position, regardless of the state that it was in before. This function is only available with the L1 status menu, when currently no signal is detected.
- <RESET> Reset the History function and all counters
- <ABORT> Quit the function and return to the Main menu

OK symbol: +

Error symbol: -

History symbol: ! means that regardless of the current status (+ or -) in the past (within the time shown on the first line) an error has occurred.

The meaning of the individual displays:

- Signal:** On its receiving-side, the ARGUS has the correct signal sent from the remote end (access or terminal depending on the operation mode TE or NT simulation) and indicates this by a +. If Rx and Tx are connected normally a "=" will be shown after the signal; in the event that they are inverted a "x" will be displayed.
- FAS:** (= **F**rame **A**lignment **S**ignal)
Indicates whether the ARGUS could correctly synchronize with the incoming 2 Mbit data stream's alternating frame identification word or message word and the, perhaps present, CRC4-superframe structure.
- CRC det:** If CRC4-monitoring is active for the access or the terminal and the ARGUS is able to synchronize itself to the CRC4 superframe, it will indicate this by displaying "CRC det +".
If "CRC det -" is displayed together with "Signal +" and "FAS +", this indicates that no CRC4 is active.
In the example, "CRC det + !" indicates that CRC4-monitoring is active, but that CRC4 errors were detected within the last 1:23 minutes (normally this is just the effect of switch on transients). Nonetheless, we recommend that you press DEL to reset the display and counter to their defined initial states so that you can see whether further errors occur that would indicate problems on Layer 1.
- Code HDB3:** Displays the transmission code used (currently fixed to HDB3)
- noA-Bit:** With the A-Bit, the remote end can indicate whether the route on its receive-side is no longer available
noA-Bit + means A=0: Idle state
noA-Bit - means A=1: Return direction is not available
- noAIS:** (**A**larm **I**ndication **S**ignal)
AIS will be set if a component on the

transmission line determines that the signal they have received is faulty (e.g., in the event, that they lose frame synchronization) and afterwards they will send a Time -1 (=AIS).

noAIS = + : No AIS occurred.

E-Bit: With the two E-Bits, E1 and E2, the remote end will report any CRC4-errors that it finds on its receive side in the first or second submultiframe (the E-Bit will be set to 0)

E-Bit11+ : if both E-Bits are set to 1, no error occurred

E-Bit11+! : A CRC4-error was found (indicated by the "!"), however the circuit is in largest part OK (see the E-Bit counter *Ecnt* and/or the CRC4 error counter *CRCErr*).

Ecnt: The E-Bit counter counts the reported E-Bit errors individually; in other word, all the cases in which a faulty CRC4 submultiframe was received (counts at a maximum of 1kHz).

CRC Err: The CRC4 error counter totals the number of CRC4 submultiframes in which errors were detected...

CRC rel: Gives the CRC4 error rate, in other words, the number of faulty CRC4 frames relative to the total number of CRC4 frames received.

Code Err: Counter for the detected HDB3 transmission code errors

Code rel: Transmission code - error rate

Frame Err: Counter for faulty 2Mbit frames

6.12 Testing Features with the Keypad

This feature is only relevant for a BRI access!

Some network operators do not support the standard DSS1 features, rather they expect the user to control the network via so-called keypad command sequences.

In these cases, the desired facility is usually activated by entering a series of characters and then sending these characters within a DSS1-specific protocol element. These so-called Keypad-Elements are imbedded in a SETUP message.

An outgoing call containing a keypad message is placed from the ARGUS by pressing the -Key.

To distinguish the call from a normal call, the first character sent is the '#'. Each step is acknowledged either acoustically (handset) or via special protocol elements (cause). These causes are displayed by the ARGUS.

To simplify the use of these functions, you can use the ARGUS's speed-dialing memory.

An example for an application:

Speed-dial number 0	4711	own number of the access under test
Speed-dial number 1	124527	tel. no. of own company
Speed-dial number 2	#*67#	Code for activating CFB
Speed-dial number 3	##67#	Code for deactivating CFB
Speed-dial number 4	#*#67#	Code for querying CFB (interrogation)
Speed-dial number 5	#*#21#	Code for querying CFU (interrogation)
Speed-dial number 6	#*#61#	Code for querying CFNR(interrogation)
Speed-dial number 7		<i>free</i>
Speed-dial number 8		<i>free</i>
Speed-dial number 9		<i>free</i>

7 Connection for a PRI network

Since there is no commonly accepted standard for the connections in the 2 Mbit sector, you will be confronted with different forms of connectors depending on the type of terminal and the network termination used.

The ARGUS changes the connector pin assignments automatically in accordance with the mode, TE or NT.

Additionally, it is also possible to change the pin assignments manually in the L1-Status menu.

7.1 Connector Pin Assignments

In TE mode, the ARGUS sends on lines 1 and 2, in NT-Mode on 4 and 5 (see illustration). An adapter cable, which is suitable for the respective ISDN network/system, can be connected using the RJ45-RJ45 adapter.

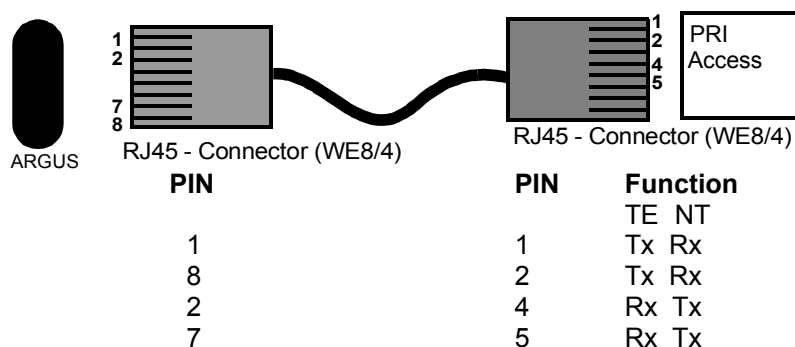

7.2 Connection to DTAG NTPM

An optional RJ45-to-splitting-plug adapter cable is available to permit connecting the ARGUS to the test jack on the front of the NTPM from "Deutschen Telekom AG".

7.3 The ARGUS 25 as Terminal

Use the RJ45 coupling to connect the RJ45-to-splitting-plug cable to the ARGUS access cable. First switch the ARGUS ON and afterwards plug the ARGUS into the NTPM.

Once you have selected the *TE-Simulation* mode, the ARGUS will serve as a PRI (S_{2M}) terminal.

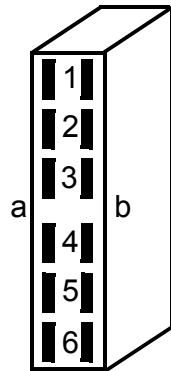

Rear view of the solder contacts

Splitting plug pin assignment:

The ARGUS in TE Mode

PIN	Function
1b	Send NT (Tx)
2b	Send NT (Tx)
5b	Receive NT (Rx)
6b	Receive NT (Rx)

The ARGUS in NT Mode

PIN	Function
1a	Receive TE (Tx)
2a	Receive TE (Tx)
5a	Send TE (Rx)
6a	Send TE (Rx)

8 Appendix

A) Acronyms

3PTY	Three party service / Three party conference
AI	Action Indicator
AOC	Advice of Charge
AOC-D	Advice of Charge Charging information during the call and at the end of the call
AOC-E	Advice of Charge Charging information at the end of the call
AWS	Call Forwarding (Anrufweiserschaltung)
BC	Bearer Capability
BER	Basic Encoding Rules / Bit Error Rate
BERT	Bit Error Rate Test
CALL PROC	CALL PROCeeding message
CCBS	Completion of Calls to Busy Subscriber
CCNR	Call Complete No Response Automatic Callback if the called party did not answer
CD	Call Deflection
CDPN	CalleD Party Number
CF	Call Forwarding
CFB	Call Forwarding Busy Forward calls when busy
CFNR	Call Forwarding No Reply Forward calls when no answer
CFU	Call Forwarding Unconditional Forward all calls
CGPN	CallinG Party Number
CLIP	Calling Line Identification Presentation Display caller's number
CLIR	Calling Line Identification Restriction Suppress display of the caller's number
COLP	Connected Line Identification Presentation Display the number of the party called
COLR	Connected Line Identification Restriction Suppress the display of the number of the party with whom one is connected
CONN	CONNect Message

CONN ACK	CONNect ACKnowledge Message
CR	Call Reference
CT	Call Transfer
CUG	Closed User Group
CW	Call Waiting Call waiting
DAD	Destination Address (1TR6)
DDI	Direct Dialling In Direct dialling in to an extension on a PBX
DISC	DISConnect Message
DM	Supplementary services (Dienstmerkmal)
DTMF	Dual Tone Multi Frequency
EAZ	Terminal Ident. No. (Endgeräteauewahlziffer - 1TR6)
ECT	Explicit Call Transfer Call transfer or directed call forwarding
E-DSS1	European Digital Subscriber Signalling System Number 1
GBG	Closed user group (CUG) (Geschlossene Benutzer Gruppe)
HLC	High Layer Compatibility
HOLD	Call Hold Hold
ISDN	Integrated Services Digital Network
INFO	INFORmation Message
LAPD	Link Access Procedure for D-channels channels
LCN	Logical channel number Channel number in X.25
LLC	Low Layer Compatibility
MCID	Malicious Call Identification
MSN	Multiple Subscriber Number
NSF	Network Specific Facilities
NT	Network Termination
OAD	Origination Address (1TR6)
PD	Protocol Discriminator
REL	RELease Message
REL ACK	RELease ACKnowledge Message
REL COMPL	RELease COMPLete Message
SCI	Sending Complete Indication
SIN	Service Indicator (1TR6)
SUB	Sub-addressing / Sub-addressing is possible

SUSP	SUSPend Message
TE	TErminAl, TErminAl Equipment
TEI	TErminAl Endpoint Identifier
TP	TErminAl Portability Moving the terminal on the bus
UUS	User-to-User Signalling Transfer of user data

B) CAUSE-Messages – DSS1 Protocol

Dec. Cause	Description
01 Unallocated (unassigned) number	No access under this call number
02 No route to specified transit network	Transit network not reachable
03 No route to destination	Wrong route or routing error
06 Channel unacceptable	B-channel for the sending system not acceptable
07 Call awarded and being delivered in an established channel	Call awarded and connected in an already existing channel (e.g., X.25 SVC)
16 Normal call clearing	Normal disconnect
17 User busy	The number called is busy
18 No user responding	No terminal equipment answered (Timer NT303 / NT310 time-out)
19 No answer from user (user alerted)	Call time too long
21 Call rejected	Call rejected (active)
22 Number changed	Call number has been changed
26 Non-selected user clearing	Incoming call not awarded to this terminal
27 Destination out of order	Destination / access out of order
28 Invalid number format (address incomplete)	Wrong call number format or call number incomplete
29 Facility rejected	The facility is not offered
30 Response to STATUS ENQUIRY	Response to status enquiry
31 Normal, unspecified	Unspecified for "normal class" (Dummy)
34 No circuit / channel available	No circuit / B-channel available
38 Network out of order	Network not operational
41 Temporary failure	Network is temporarily not operational
42 Switching equipment congestion	Switching equipment is overloaded
43 Access information discarded	Access information could not be transferred
44 Requested circuit / channel not available	Requested circuit / B-channel is not available
47 Resources unavailable, unspecified	Unspecified for "resource unavailable class" (Dummy)
49 Quality of service unavailable	The requested quality of service is not available
50 Requested facility not subscribed	Requested service attribute is not subscribed
57 Bearer capability not authorized	The requested bearer capability is not enabled
58 Bearer capability not presently available	The requested bearer capability is not currently available

63	Service or option not available	"Service unspecified or option not available class" (Dummy)
65	Bearer capability not implemented	Bearer capability is not supported
66	Channel type not implemented	Channel type is not supported
69	Requested facility not implemented	Requested facility is not supported
70	Only restricted digital information bearer capability is available	Only limited bearer capability is available
79	Service or option not implemented, service unspecified or option not implemented class" (Dummy)	Unspecified
81	Invalid call reference value	Invalid call reference value
82	Identified Channel does not exist	Requested channel is invalid
83	A suspended call exists, but this call identity does not	The call identity entered is the wrong one for the parked call
84	Call identity in use	The call identity is already in use
85	No call suspended	No call has been parked
86	Call having the requested call identity has been cleared	The parked call has been cleared
88	Incompatible destination	Incompatible destination
91	Invalid transit network selection	Invalid format for the transit network identifier
95	Invalid message, unspecified	Unspecified for "Invalid message class" (Dummy)
96	Mandatory information element is missing	Mandatory information element is missing
97	Message type non-existent or not implemented	This type of message is in this phase not permitted, not defined or not supported
98	Message not compatible with call state or message type non-existent or not implemented	The content of the message is in this phase not permitted, not defined or not supported
99	Information element non-existent or not implemented	The content of the information element is in this phase not permitted, not defined or not supported
100	Invalid information element contents	Invalid content in information element
101	Message not compatible with call state	Message not valid in this phase
102	Recovery on timer expired	Error handling routine started due to time-out
111	Protocol error, unspecified	Unspecified for "protocol error class" (Dummy)
127	Interworking, unspecified	Unspecified for "interworking class" (Dummy)

C) CAUSE-Messages – 1TR6 Protocol

Dec. Cause	Description
01 Invalid call reference value	Invalid call reference value
03 Bearer service not implemented	The service is not available in the central office or at another location in the network or the service has not been subscribed.
07 Call identity does not exist	Unknown call identity
08 Call identity in use	Call identity is already assigned to a "suspended" connection.
10 No channel available	No further B-channel is free on the subscriber's access. (only significant locally)
16 Requested facility not implemented	The entered FAC-Code is unknown in this network.
17 Requested facility not subscribed	The requested facility is not available, because the initiating remote subscriber is not authorized.
32 Outgoing calls barred	Outgoing calls are not possible due to the barring
33 User access busy	If the sum of the number of free B-channels, the number of occupied B-channels, the number of awarded B-channels and the number of calls without B-channel assignment equals four, new incoming calls will be cleared from the network. The calling subscriber receives a DISC with the cause "user access busy" (= first busy) and a busy signal.
34 Negative CUG comparison	Connection not possible due to negative CUG comparison
35 Non-existent CUG	This CUG (GBG) does not exist
37 Communication link as SPV not permitted	A connection is not possible, since for example, the RFNR-test was negative
53 Destination not obtainable	A connection cannot be made due to a wrong destination, service or supplementary services.
56 Number changed	Subscriber-B's call number has changed.
57 Out of order	The remote terminal is not ready.
58 No user responding	No terminal has answered the incoming SETUP or the subscriber call was disconnected, it is assumed that someone is present (Time-out for ringing T3AA).
59 User busy	Subscriber-B is busy
61 Incoming calls barred	Subscriber-B has blocked incoming calls or the requested service is not supported by Subscriber-B.

62	Call rejected	<p>To Subscriber-A: The requested connection is actively rejected by Subscriber-B (by sending a DISC as answer to the incoming SETUP). Another terminal is in the setup phase with the incoming call: The call has already been accepted by another terminal on the bus.</p>
89	Network congestion	Network congested, e.g., switching equipment congestion, no conference set free, ...
90	Remote user initiated	Rejected or disconnected by remote end (subscriber or exchange).
112	Local procedure error	<p>Sent in a REL Disconnect due to local errors (e.g., not valid messages or parameters, time-out, ...).</p> <p>Sent in a SUSP REJ Due to another already active supplementary service, the connection may not be "suspended".</p> <p>Sent in a RES REJ There is no "suspended" connection.</p> <p>Sent in a FAC REJ No further supplementary service request is possible, since there is still one being processed or the supplementary service requested is not available in the current state of the connection.</p>
113	Remote procedure error	Caused by error at remote end.
114	Remote user suspended	Connection at the remote end is in the "hold" or "suspend" state.
115	Remote user resumed	Connection at the remote end is no longer in the "hold" or "suspend" or "conference" state.
127	User Info discarded locally	<p>The message USER INFO is rejected locally. The cause is given in the message CON CON. Length entry (=0) Normal disconnect (e.g., in REL as answer to a DISC from subscriber or a change of service in a DISC): Command to the terminal to release the B-channel.</p>

D) ARGUS Error Messages

Error Number	Error Class	Cause	Description
0	E	Network	The network is not in a state defined for DSS1 or 1TR6. It may be that this state is normal for a PBX.
1 to 127	B,C,D,E	Network	DSS1 or 1TR6 causes
150	E	ARGUS	An error occurred during the supplementary service test. Frequent cause: no response from network
152	B	ARGUS	The CF-Test was started with the wrong own number.
153	E	ARGUS	no HOLD is available, but HOLD is required to test the supplementary service (ECT, 3pty)
154	E	ARGUS	CLIR or COLR could not be tested, since CLIP or COLP is not available
161	B	ARGUS	The party called did not answer within the prescribed time (approx.10 sec)
162	B	ARGUS	A call was setup to a remote subscriber, instead of being setup – as was expected – to your own number.
163	E	ARGUS	The Auto-Test could not setup a connection and therefore the AOC/D supplementary service could not be tested.
199	B	ARGUS	A call number was entered.
201	A	ARGUS	Network did not confirm acceptance of the call (CONN sent, no CONN_ACK received from network)
204	A	ARGUS	- Layer 2 connection was cleared-down - No response to SETUP (call setup) - Layer 2 connection could not be setup
205	A	ARGUS	Reestablish the Layer 2 Connection

210	A	ARGUS	No response to the clear-down (REL sent, no REL_CMP/REL_ACK received from network)
220	A	ARGUS	Remote end signaled that it is in State 0.
245	E	ARGUS	Keypad sent via ESC, but no response was received from network
250	E	ARGUS	FACility was sent, but no response was received from network

X.31 Test – Error messages

X.31 Causes

0 to 255	Network	See ISO 8208: 1987(E) Table 5- Coding of the clearing cause field in clear indication packets, page 35
257	ARGUS	no response from network (for a CALL-REQUEST or CLEAR-REQUEST)
258	ARGUS	Unexpected or wrong answer from network (no CALL-CONNECTED or CLEAR-INDICATION as response to a CALL-REQUEST)
259	ARGUS	The network has indicated in a DIAGNOSTIC message that the logical channel is invalid. Cause: No (=1) or a wrong LCN was set.
512	ARGUS	It was not possible to determine an internal or external cause. Cause: Layer 2 could not be setup or remote end does not support X.31
65535	ARGUS	X.31 Layer 3 test was not performed. The error can only occur in a test log.

X.31 Diagnostic (only for a cause less than 256)

0 to 255	Network	See ISO 8208: 1987(E) Figure 14A page 121 Figure 14B page 123ff And/or CCITT Recommendation X.25, Annex E
-----------------	---------	---

E) Package contents

Included in the package are:

- ARGUS including batteries
- ARGUS ISDN-Test Adapter
- BRI connecting cable
- PRI connecting cable
- 9V plug-in power supply
- Shock-absorbing PVC jacket
- Cable for analog and U-interfaces
- User's Guide

- WINplus CD
- Serial cable Type P2
- Guarantee card & registration
- ARGUS carrying case